

Washing machine
Lave-linge
Wasmachine
Lavadora

981282 - WF 510 D W566C

INSTRUCTIONS FOR USE02
CONSIGNES D'UTILISATION30
GEBRUIKSAANWIJZINGEN60
INSTRUCCIONES DE USO90

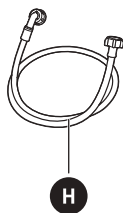

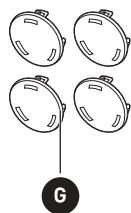
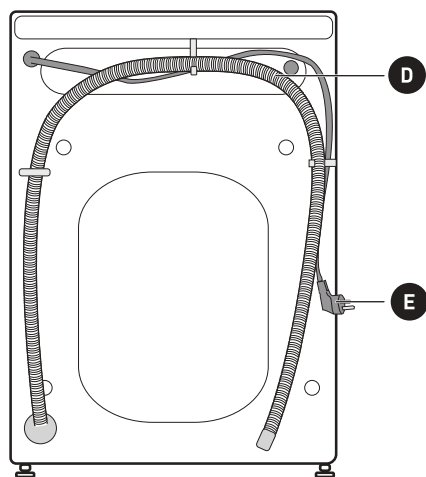
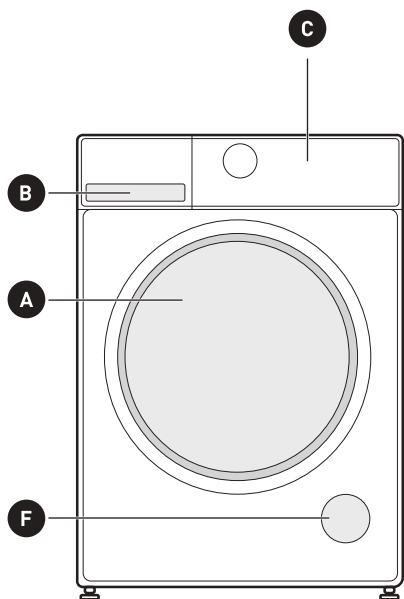



Thank you!

Thank you for choosing this HIGHONE product. HIGHONE products are chosen, tested, and recommended by ELECTRO DEPOT, so you can be sure you are getting a top-quality, easy-to-use product that won't let you down.

We're confident your new device will be a pleasure to use every day!

Welcome to ELECTRO DEPOT.



Table of Contents

A

Product overview

Parts
Specifications

B

Product usage

Installation
Operation

C

Cleaning and maintenance

Cleaning and maintenance
Trouble shooting
Transport

Product fiche

Parts

A Door

B Detergent dispenser

C Control panel

D Drain hose

E Power supply cord

F Service flap

G 4 x Cover caps

H 1 x Supply hose cold water

I Acoustic sponge (optional)

**Note:**

- The product picture is for illustration only, please refer to real product as reference.

Specifications

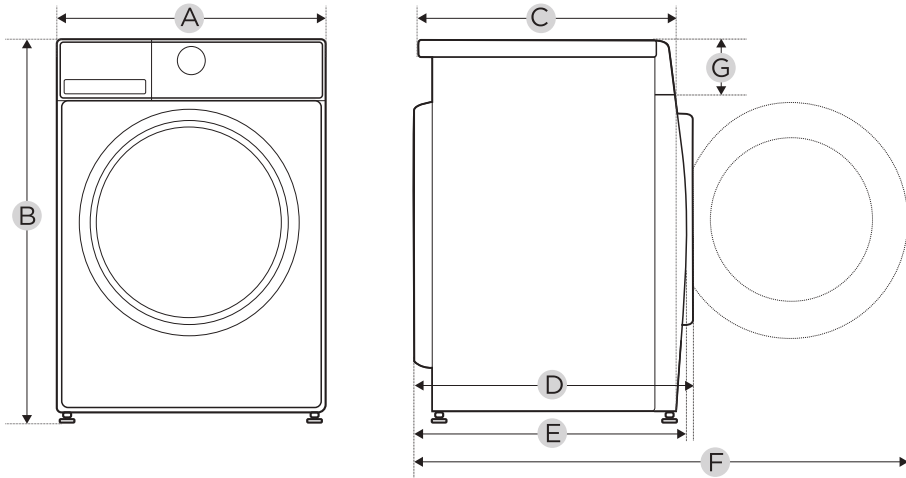

Model: **981282 - WF 510 D W566C**

Power Supply: 220-240 V~, 50 Hz

MAX. Current: 10A

Standard Water Pressure: 0,05 MPa ~ 1 MPa

Washing Capacity: 5,0 kg

Dimension

A: 595 mm

B: 850 mm

C: 435 mm

Weight: 52 kg

Rated Power: 2 000 W

Reference Dimension

D: 440 mm

E: 400 mm

F: 900 mm

G: 156 mm

Installation

Tools Needed If Installation By Yourself (not include)

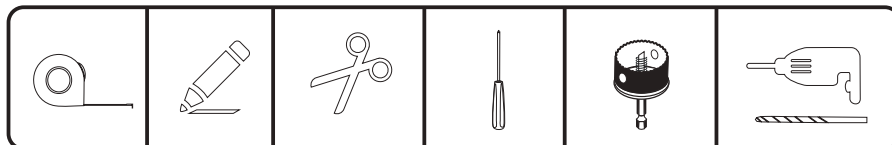

Installation area

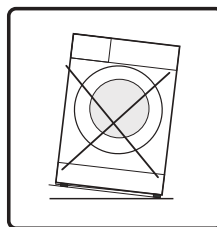
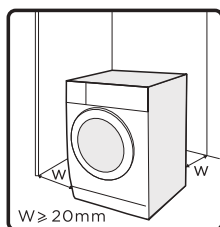

Warning!

- Stability is important to prevent the product from wandering!
- Make sure the machine is standing leveled and stable.
- Make sure that the product does not stand onto the power cord.
- Make sure to maintain the minimum distances from the walls as shown in the picture.

Before installing the machine, the location characterized as follows shall be selected:

- Rigid, dry, and level surface.
- Avoid direct sunlight.
- Sufficient ventilation.
- Room temperature is above 5°C.
- Keep far away from the heat sources such as coal or gas burning appliances.

Unpacking the washing machine

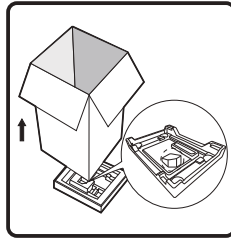

Warning!

- Packaging material (e.g. Films, Styrofoam) can be dangerous for children.
- There is a risk of suffocation ! Keep all packaging well away from children.

1. Remove the cardboard box and styrofoam packing.
2. Lift the machine and remove the base packaging.
3. Remove the tape securing the power supply cord and drain hose.
4. Remove the inlet hose from the drum.

Remove transport bolts



Warning!

- You must remove the transport bolts from the backside before using the product.

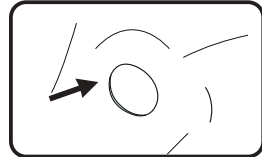
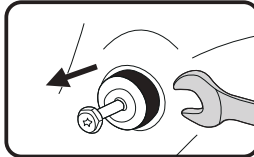
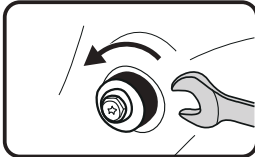

1. Loosen the 4 transport bolts with a spanner.
2. Remove the bolts including the rubber parts and keep them for future use.
3. Close the holes using the cover caps.

Levelling the washing machine



Warning!

- The lock nuts on all four feet must be screwed tightly against the housing.

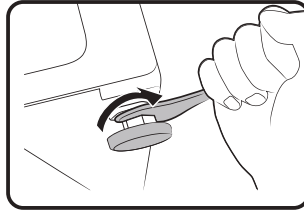

1. Loosen the lock nut.
2. Turn the foot until it reaches the floor.
3. Adjust the legs and lock the nuts with a spanner. Make sure the machine is level using a spirit level.

Connect the water supply hose



Warning!

To prevent leakage or water damage, follow the instructions in this chapter.

- Do not kink, crush or modify water inlet hose.

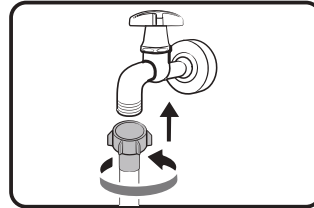
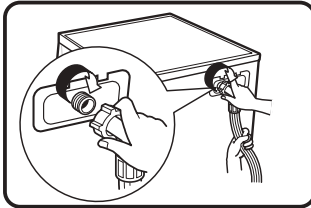

Connect the water supply hose to the water inlet valve and a water tap with cold water as indicated.



Note:

- Connect manually, do not use tools. Check if the connections are tight.

Drain Hose



Warning!

- Do not kink or protract the drain hose.
- Position drain hose properly, otherwise damage might result of water leakage.
- It is not allowed to remove the buckle of drain pipe.

There are two ways to place the end of drain hose:

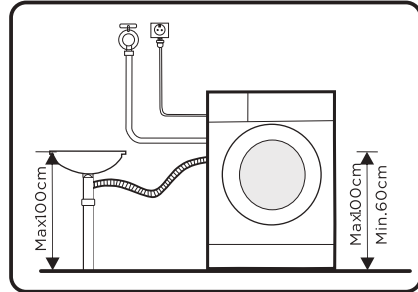
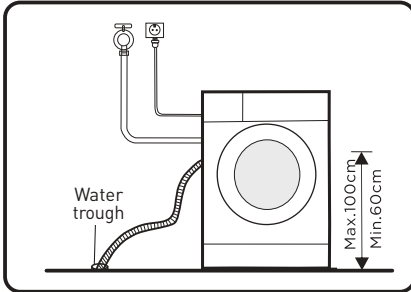

1. Put it into the water trough.
2. Connect it to the branch drain pipe of the trough.

Acoustic Sponge



Note:

- Please make sure to assemble the acoustic sponges, which can effectively reduce the noise caused by the machine while working, in order to provide you with a more peaceful and quiet living environment.

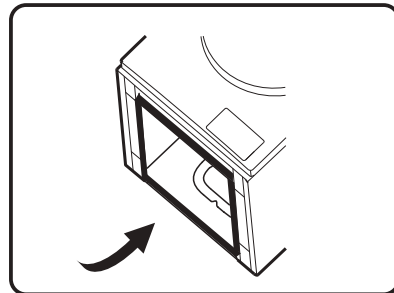
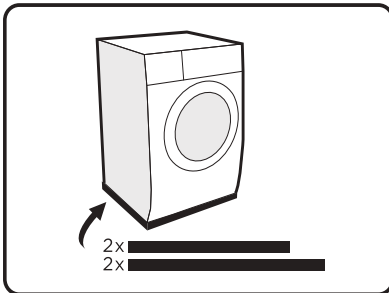

1. Get the machine laid on the floor, using some soft material like foam or clothes between the machine and floor for a protection.
2. Stick the 2x longer sponges to the longer bottom edges of machine, and the 2x shorter sponges to the shorter bottom edges.

Operation

Quick Start



Caution!

- Before washing, please make sure the washing machine is installed properly.
- Your appliance was thoroughly checked before it left the factory. To remove any residual water and to neutralize potential odors, it's recommended to clean your appliance before first use. For this reason, recommended to clean the inner drum by running the «Drum Clean» or other program with the optional temperature of 90 °C. Be careful not to put laundry and detergent in the machine.

• Before Washing

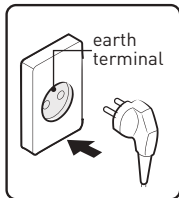

①

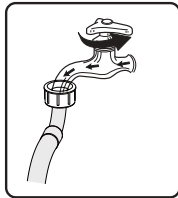

②

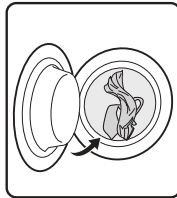

③

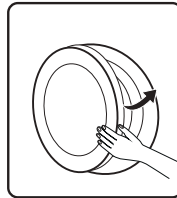

④

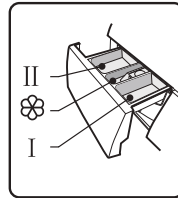

⑤

1. Plug in
2. Open tap
3. Load
4. Close door
5. Add detergent



Note:

- Detergent need to be added in compartment I if the pre-wash function is selected.

- **Washing**

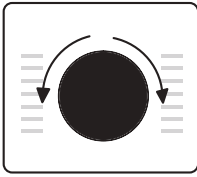

①

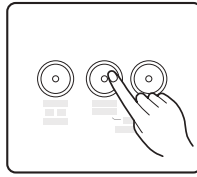

②

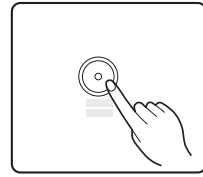

③

1. Select programme
2. Select function or remain default settings
3. Press Start/Pause to start the program

**Note:**

1. If default is selected, step 2 can be skipped.
2. The function button line chart is for reference only, please refer to real product as standard.

- **After Washing**

Buzzer beep.

Before Each Washing

- The ambient temperature of the machine should be 5°C-40°C. If used under 0°C, the inlet valve and draining system may be damaged. If the machine is installed under freezing conditions, it should be transferred to normal ambient temperature to ensure the water supply hose and drain hose can unfreeze before use.
- Please check your laundry care labels and the detergent use instructions before wash. Use non-foaming or less-foaming detergent suitable for washing machine properly.

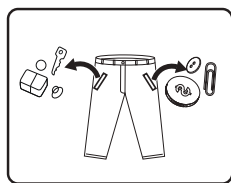

①

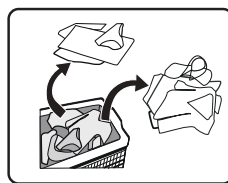

②

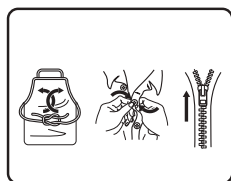

③

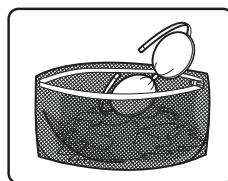



④

1. Take all items out of the pockets
2. Sort laundry according to color and textile type
3. Tie together long textile strips and belts, close zips and button
4. Put small items into a laundry bag

**Warning!**

- Do not wash articles that have been cleaned in, washed in, soaked in, or dabbed with combustible or explosive substances like wax, oil, paint, gasoline, alcohol, kerosene, and other flammable materials.
- Washing single clothes items may easily create big eccentricity. Therefore it is suggested to add one or two more laundry items to the wash so that spin can be done smoothly.
- Do not wash, spin, or dry water-proof seats, mats, or clothing.

Detergent Dispenser

- I Pre wash
- II Main wash
-  Softener
-  Release button to pull out the dispenser

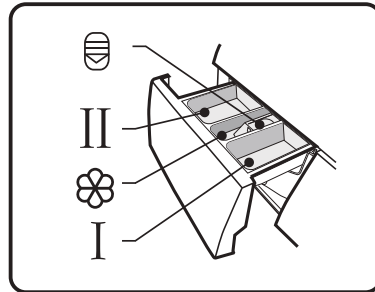

Caution!

- Detergent only need to be added in "compartment I" after selecting pre-wash function.
- Do not put laundry beads into the detergent dispenser.

Control Panel

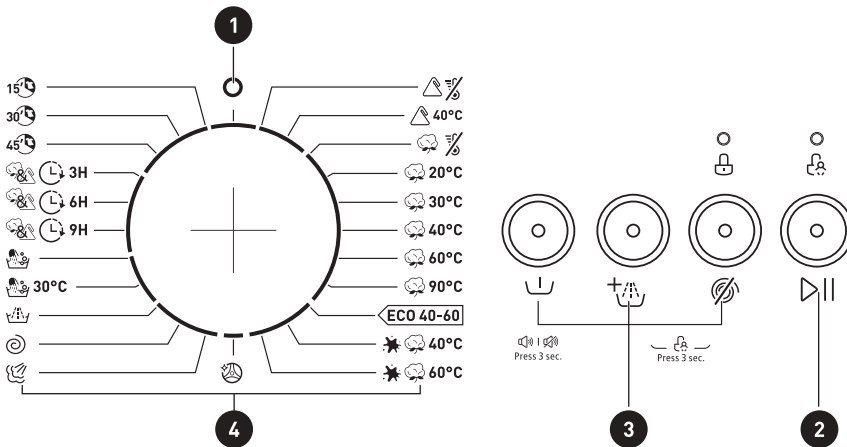

1 OFF

Turn the appliance on and off.

2 Start/Pause

























Start or pause your programme.

3 Option

This allows you to select additional functions and will light when selected.

4 Programmes

Available according to the laundry type.

Programme	I	II / 	
 Synthetic	○	●	○
 Synthetic 40 °C	○	●	○
 Cold Wash	○	●	○
 Cold Wash 20°C	○	●	○
 Cotton 30°C	○	●	○
 Cotton 40°C	○	●	○
 Cotton 60°C	○	●	○
 Cotton 90°C	○	●	○
 ECO 40-60		●	○
 Cotton Intensive 40°C		●	○
 Cotton Intensive 60°C		●	○
 Drum Clean			○
 Steam Wash		●	○
 Spin Only			
 Rinse&Spin			○
 Delicate 30°C		●	○
 Delicate		●	○
 Ends in 9H		●	○
 Ends in 6H		●	○
 Ends in 3H		●	○
 Quick Wash 45'		●	○
 Quick Wash 30'		●	○
 Quick Wash 15'		●	○

● Means must ○ Means optional

Detergent Recommendation

Recommended washing detergent	Type of laundry and textile	Wash cycles	Washing temp. °C
Heavy-duty detergent with bleaching agents and optical brighteners	White laundry made from boil-proof cotton or linen	Cotton, ECO 40-60	30/40/60/90
Colour detergent without bleaching agent and optical brighteners	Coloured laundry made from cotton or linen	Cotton, ECO 40-60, Cold Wash	Cold/20/30/40/60/90
Color or mild detergent without optical brighteners	Coloured laundry made from easy care fibres or synthetic materials	Cold Wash, Synthetic	Cold/20/40
Mild washing detergent	Delicate textiles, silk, viscose	Synthetic	Cold /40

**Note:**

- Agglomerating or ropy detergent or additive can be diluted in some water before pouring it into the detergent dispenser, to avoid its inlet to get blocked and thus cause a water overflow.
- Please choose the suitable type of detergent to get a maximum of washing performance and a minimum of water and energy consumption.
- To achieve the best cleaning result a proper detergent dosing is important.
- Use a reduced detergent amount if the drum is not filled completely.
- Always adjust the amount of detergent to the water hardness, if your tap water is soft, use less detergent.
- Dose according to how dirty your laundry is, less dirty clothes require less detergent.
- Highly concentrated (compact detergent) requires particularly accurate dosing.

Following symptoms are a sign of detergent overdosing:





















- Heavy foam formation
- Poor washing and rinsing result

Following symptoms are a sign of detergent underdosing:

- Laundry turns grey
- Built-up of limescale deposits on the drum, the heating element and/or the laundry























Programmes

Programmes are available according to the laundry type.

Programmes		
	Synthetic	Wash synthetic articles, for example: shirts, coats, blending. While washing the knitting textiles, detergent quantity shall be reduced due to its loose string construction and easily forming bubbles.
	Cold Wash	Cold water to wash clothes.
    	Cotton	Hard-wearing textiles, heat-resistant textiles made of cotton or linen.
	ECO 40-60	Able to clean normally soiled cotton laundry declared to be washable at 40 °C or 60 °C, together in the same cycle.
 	Cotton Intensive	To increase the washing effects, washing time is increased.
	Drum Clean	It applies 90 °C high temperature sterilization to make the clothes washing more green. When this procedure is performed, the clothes or other washing cannot be added. When proper amount of chlorine bleaching agent is put in, the barrel cleaning effect will be better. The customer can use this programme regularly according to the need.
	Steam Wash	The Steam Wash can deeply penetrate the fiber which effectively eliminate bacterias and germs preventing odors and protecting health.
	Spin Only	Spins and drains the water.
	Rinse & Spin	Rinses and then spins the laundry, and then drains the water.
	Delicate	For delicate, washable textiles, e.g. made of silk, satin, synthetic fibres or blended fabrics.
  	Ends in	The function can be set with this programme, the total time including washing time and delaying time is 3h,6h or 9h.
  	Quick Wash	It is suitable for washing few and not very dirty clothes quickly. The washing time is 15', 30' or 45'.

**Note:**

- Reference to your product to select the programmes.

Programme	Load(kg)	Display Time
	5,0	5,0
 Synthetic	2,5	2:20
 Synthetic 40 °C	2,5	2:20
 Cold Wash	5,0	1:00
 Cold Wash 20°C	5,0	1:01
 Cotton 30°C	5,0	2:40
 Cotton 40°C	5,0	2:40
 Cotton 60°C	5,0	2:45
 Cotton 90°C	5,0	2:50
 ECO 40-60	5,0	3:08
 Cotton Intensive 40°C	5,0	3:48
 Cotton Intensive 60°C	5,0	3:53
 Drum Clean	--	1:18
 Steam Wash	5,0	0:12
 Spin Only	2,5	1:27
 Rinse&Spin	5,0	0:20
 Delicate 30°C	2,0	0:50
 Delicate	2,0	0:48
 Ends in 9H	5,0	0:59
 Ends in 6H	5,0	0:59
 Ends in 3H	5,0	0:59
 Quick Wash 45'	2,0	0:45
 Quick Wash 30'	2,0	0:30
 Quick Wash 15'	2,0	0:15

**Note:**

- The parameters in this table are only for user's reference. The actual parameters may be different with the parameters in above mentioned table.

WF 510 D W566C							
Cycle	Nominal capacity in kg	Temperature setting	Cycle duration in h:min	Energy consumption in kWh/cycle	Water consumption in L/cycle	Highest washing temperature °C ⁽¹⁾	Residual moisture in %/ Spin speed ⁽²⁾
Synthetic	2,5	Cold	2:20	0,327	50	Cold	65%/1 000
Cold Wash 20°C	2,5	20	1:01	0,201	34	20	65%/1 000
Cotton 60°C	5,0	60	2:45	1,175	51	60	70%/1 000
ECO 40-60 ⁽³⁾	5,0	-	3:08	0,769	46,0	37	71,9 %/1 000
	2,5	-	2:30	0,485	37,0	31	71,9 %/1 000
	1,5	-	2:30	0,368	34,0	28	71,9 %/1 000
Cotton Intensive 40°C	5,0	40	3:48	0,994	51	40	65 %/1 000
Quick Wash 15'	2,0	Cold	0:15	0,035	31	Cold	75%/800

- The above data is for reference only, and the data may change due to different actual use conditions.
- The values given for programmes other than the ECO 40-60 programme are indicative only.
- Cold Wash 20°C is able to clean lightly soiled cotton laundry, at a nominal temperature of 20 °C, which complies with the regulation (EU) 2019/2023.
- Compliant to EN 60456:2016+A11:2020 With (EU) 2019/2014, (EU) 2019/2023, (EU) 2021/340, (EU) 2021/341.
The EU energy efficiency class is: S
Energy test program: ECO 40-60. Other as the default.
Half load for 5.0kg machine: 2.5kg.
Quarter load for 5.0kg machine: 1.5kg.

- ⁽¹⁾ The highest temperature reached by the laundry in the wash cycle for at least 5 minutes.
- ⁽²⁾ Residual moisture after the wash cycle in water content percent and the spin speed at which this was achieved.
- ⁽³⁾ The ECO 40-60 programme is able to clean normally soiled cotton laundry declared to be washable at 40°C or 60°C, together in the same cycle. This programme is used to assess the compliance with the regulation (EU) 2019/2023.

The most efficient programmes in terms of energy consumption are generally those that perform at lower temperatures and longer duration.

Loading the household washing machine up to the capacity indicated for the respective programmes will contribute to energy and water savings.

Noise and remaining moisture content are influenced by the spinning speed: the higher the spinning speed in the spinning phase, the higher the noise and the lower the remaining moisture content.













Caution!

- If there is any break in the power supply while the machine is operating, a special memory stores the selected programme. The machine will continue the programme when the power supply is re-established.

Option

	Cycle	Default Temp.(°C)	Default spin speed (rpm)	Additional functions
	Synthetic	Cold	1 000	Pre Wash, Extra Rinse, No Spin
	Synthetic 40°C	40	1 000	Pre Wash, Extra Rinse, No Spin
	Cold Wash	Cold	1 000	Pre Wash, Extra Rinse, No Spin
	Cold Wash 20°C	20	1 000	Pre Wash, Extra Rinse, No Spin
	Cotton 30°C	30	1 000	Pre Wash, Extra Rinse, No Spin
	Cotton 40°C	40	1 000	Pre Wash, Extra Rinse, No Spin
	Cotton 60°C	60	1 000	Pre Wash, Extra Rinse, No Spin
	Cotton 90°C	90	1 000	Pre Wash, Extra Rinse, No Spin
	ECO 40-60	--	1 000	
	Cotton Intensive 40°C	40	1 000	No Spin
	Cotton Intensive 60°C	60	1 000	No Spin

	Drum Clean	90	--	
	Steam Wash	40	1 000	Extra Rinse, No Spin
	Spin Only	-	1 000	No Spin
	Rinse & Spin	-	1 000	Extra Rinse, No Spin
	Delicate 30°C	30	600	Extra Rinse, No Spin
	Delicate	Cold	600	Extra Rinse, No Spin
	Ends in 3H/6H/9H	40	1 000	
	Quick Wash 45'	40	800	No Spin
	Quick Wash 30'	30	800	No Spin
	Quick Wash 15'	Cold	800	No Spin

**Note:**

- For the maximum spin speed, program time, and other details of the ECO 40-60 program, please refer to the content on the Product Fiche page.
- The table shows which cycle offers which options for adjustment. If an adjustment is not possible for a cycle.

**Pre Wash**

The Prewash function can get an extra wash before main wash, it is suitable for washing the dust rises to surface of the clothes; You need to put detergent into the Case (I) when select it.

**Extra Rinse**

The laundry will undergo extra rinse once after you select it.

**No Spin**

It will not spin if you choose this function.

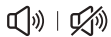
**Mute the buzzer**

Choose the Programme



Press the [Prewash] button for 3sec. the buzzer is mute.

To act the buzzer function, press the button again for 3 seconds. The setting will be kept until the next reset.

**Caution!**

- After Muting the buzzer function, the sounds will not be activated any more.

**Child Lock**

To avoid mis operation by children.

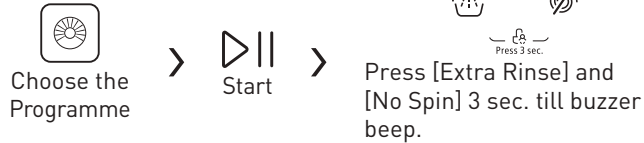
**Caution!**

- Only press and hold the two buttons can release "Child Lock", even power off, switch off and program end, the "Child Lock" will lock all buttons except power button and "Child Lock" button.
- Please release "Child Lock" before selecting program and starting washing.

**Note:**

Usage counter

1. Unplug the equipment for 10s and reconnect again.
2. Power on and within 10s, please press "Prewash" and "No Spin" on control panel simultaneously and continuously for around 5s until the buzzer beep.
3. The number of times the light flashes represents an Arabic digit, for example, the usage count of equipment is 3 456, "Prewash" flashes 3 times; "Extra Rinse" flashes 4 times; "No Spin" flashes 5 times; "Pause/Start" flashes 6 times.
4. Repeat step 1 again and customer can resume to normal operation.

Cleaning and maintenance



Warning!

- Always unplug the appliance and close the water tap before cleaning and maintenance.

Cleaning the Cabinet

Proper maintenance on the washing machine can extend its working life. The surface can be cleaned with diluted non-abrasive neutral detergents when necessary. If there is any water overflow, use a towel to wipe it off immediately.

Never use sharp items to clean the appliance.



Caution!

- Never use abrasive or caustic agents, formic acids or its diluted solvents or similar substances, like alcohol or chemical products.

Cleaning the Drum

Any rust stains left inside the drum by metal articles must be removed immediately using chlorine-free detergents. Never use steel wool for cleaning the drum!



Note:

- Keep any laundry away from the machine while cleaning the drum.

Cleaning the Door Seal and Glass

Wipe the glass and seal after each wash to remove lint and stains. If lint builds up it can cause leakages.

Remove any coins, buttons and other objects from the seal after each wash.

Clean the door seal and glass every month to ensure the normal operation of the appliance.

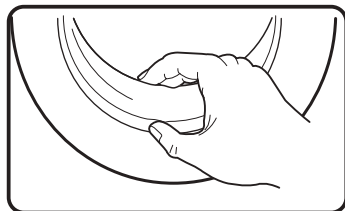

Cleaning the Inlet Filter



Note:

- Diminishing water flow is a sign that the filter need to be cleaned.

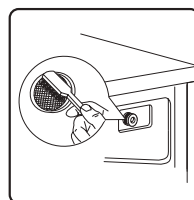
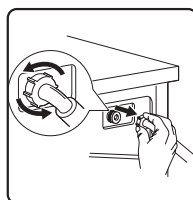
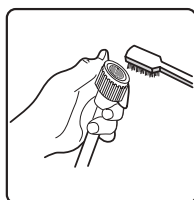
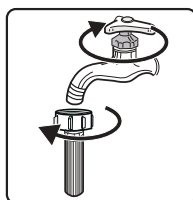

1. Close the tap and remove the water supply hose from it.
2. Clean the filter with a brush.
3. Unscrew the water supply hose from the backside of the machine. Pull out the filter with long nose pliers.
4. Use a brush to clean the filter.
5. Reinstall the filter to the water inlet and reconnect the water supply hose.
6. Clean the Inlet filter every 3 months to ensure the normal operation of the appliance.

Clean The Detergent Dispenser

1. Press down the release [] on the softener cover and pull the dispenser drawer out of the recess. Clean the inside of the recess with a brush.
2. Lift the softener cover off the dispenser drawer and wash both items with water.
3. Restore the softener cover and push the drawer back into the recess.

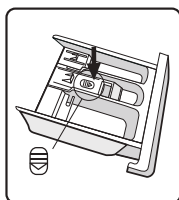

①

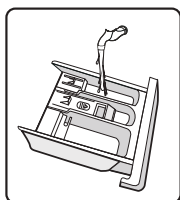

②

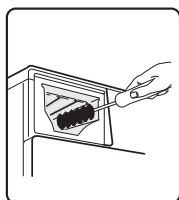

③

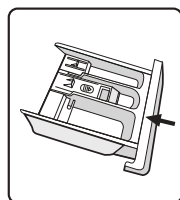

④

1. Press the release and remove the dispenser.
2. Clean the dispenser drawer and the softener cover under water.
3. Clean the recess with a soft brush.
4. Insert the dispenser drawer.



Note:

- Do not use abrasive or caustic agents to clean plastic parts.
- Clean the detergent dispenser every 3 months to ensure the normal operation of the appliance

Cleaning the Drain Pump Filter



Warning!

- Make sure that the machine has finished the washing cycle and is empty. Switch it off and unplug it before cleaning the drain pump filter.
- Be careful of hot water. Wait for water cooling down. Risk of scalding!
- Clean the filter periodically every 3 months to ensure the normal operation of the appliance.

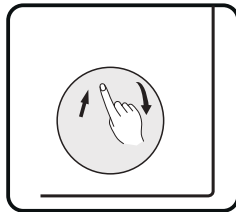

①

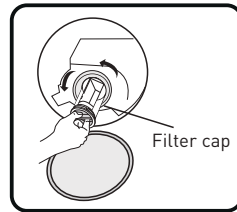

②

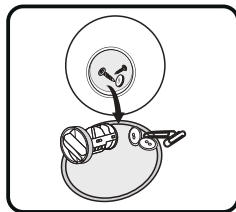

③

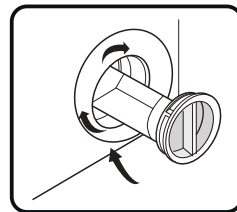

④

1. Open the lower cover cap.
2. Open the filter by turning to the counter clockwise.
3. Remove extraneous matter.
4. Close the lower cover cap.



Caution!

- When the appliance is in use and depending on the programme selected there can be hot water in the pump. Never remove the pump cover during a wash cycle, always wait until the appliance has finished the cycle, and is empty. When replacing the cover, ensure it is securely re-tightened.

Trouble shooting

Whenever there is a problem with the appliance, check if you can solve it following the tables below.

Description	Possible cause	Solution
Appliance does not start	<ul style="list-style-type: none"> • Door is not closed properly. • Clothes are stuck. 	<ul style="list-style-type: none"> • Close the door properly and restart. • Check the laundry.
Door can't be opened	<ul style="list-style-type: none"> • Safety protection is activated. 	<ul style="list-style-type: none"> • Disconnect the power and restart.
Water leakage	<ul style="list-style-type: none"> • Connections are not tight enough. 	<ul style="list-style-type: none"> • Check and fasten the water inlet pipe. • Check and clean the outlet hose.
Detergent residues in the detergent dispenser	<ul style="list-style-type: none"> • Detergent is damp and/or clotted. 	<ul style="list-style-type: none"> • Clean and wipe the detergent dispenser dry.
Indicator or display does not work	<ul style="list-style-type: none"> • PC board or harness have connection problems. 	<ul style="list-style-type: none"> • Switch off the power and check if the mains plug is connected properly.
Abnormal noise	<ul style="list-style-type: none"> • Fixing bolts still in place. • Floor is not solid or level. 	<ul style="list-style-type: none"> • Check if the fixing bolts have been removed. • Make sure the appliance is installed on a solid and level floor.

Product fiche

Supplier's name or trade mark^{(a),(c)}:

Supplier's address^{(a),(c)}:

Model identifier^(a): WF 510 D W566C

General product parameters:

Parameter	Value		Parameter	Value	
Rated capacity ^(b) (kg)	5,0		Dimensions in cm ^{(a),(c)}	Height	85
				Width	60
				Depth	40
Energy efficiency index (EEI _w) ^(b)	79,9		Energy efficiency class ^(b)	D ^(d)	
Washing efficiency index ^(b)	1,031		Rinsing effectiveness (g/kg) ^(b)	5,0	
Energy consumption in kWh per cycle, based on the eco 40-60 programme. Actual energy consumption will depend on how the appliance is used.	0,602		Water consumption in litre per cycle, based on the eco 40-60 programme. Actual water consumption will depend on how the appliance is used and on the hardness of the water.	41	
Maximum temperature inside the treated textile ^(b) [°C]	Rated capacity	37	Weighted remaining moisture content ^(b) (%)	71,9	
	Half	31			
	Quarter	28			
Spin speed ^(b) (tr/min)	Rated capacity	1 000	Spin-drying efficiency class ^(b)	D ^(d)	
	Half	1 000			
	Quarter	1 000			
Programme duration ^(b) (h:min)	Rated capacity	3:08	Type	free-standing	
	Half	2:30			
	Quarter	2:30			

Product fiche

Airborne acoustical noise emissions in the spinning phase ^(b) (dB(A) re 1 pW)	79	Airborne acoustical noise emission class (spinning phase)	C ^(d)
Off-mode (W) (if applicable)	0,50	Standby mode (W) (if applicable)	1,00
Delay start (W) (if applicable)	4,00	Networked standby (W) (if applicable)	N/A

Minimum duration of the guarantee offered by the supplier^{(a),(c)}:

This product has been designed to release silver ions during the washing cycle	NO
---	----

Additional information:

Weblink to the supplier's website, where the information in point 9 of Annex II to Commission Regulation (EU) 2019/2023⁽¹⁾ is found:

^(a) this item shall not be considered relevant for the purposes of Article 2(6) of Regulation (EU) 2017/1369,

^(b) for the eco 40-60 programme.

^(c) changes to these items shall not be considered relevant for the purposes of paragraph 4 of Article 4 of Regulation (EU) 2017/1369.

^(d) if the product database automatically generates the definitive content of this cell, the supplier shall not enter these data.

Merci !

Merci d'avoir choisi ce produit HIGHONE.
Choisis, testés et recommandés par ELECTRO DEPOT,
les produits de la marque HIGHONE vous assurent
une utilisation simple, une performance fiable et
une qualité irréprochable.
Grâce à cet appareil, vous savez que chaque utilisation
vous apportera satisfaction.

Bienvenue chez ELECTRO DEPOT.

Visitez notre site Internet : www.electrodepot.fr
www.electrodepot.be

VOTRE AVIS COMPTE !



**PARTAGEZ
VOTRE EXPERIENCE
SUR LES PRODUITS**

Parce que votre satisfaction est notre priorité, nous vous proposons
de donner votre avis sur ce produit. Il sera transmis et analysé par
nos équipes afin d'améliorer continuellement le produit.

Donnez votre avis sur <http://www.electrodepot.fr/avis-client>



ELECTRO DEPOT

30

FR

Table des matières

A

Aperçu de l'appareil

Description des pièces
Caractéristiques

B

Utilisation de l'appareil

Installation
Fonctionnement

C

Nettoyage et entretien

Nettoyage et entretien
Dépannage
Transport

Fiche produit

Les notices sont aussi disponibles sur le site
<http://www.electrodepot.fr/sav/notices/>
<http://www.electrodepot.be/fr/sav/notices>

Description des pièces

A Porte

B Distributeur de lessive

C Panneau de commande

D Tuyau de vidange

E Cordon d'alimentation

F Clapet pour réparation

G 4 couvercles

H 1 tuyau d'arrivée d'eau froide

I Mousse acoustique (facultative)



Remarque :

- L'image du produit est fournie à titre d'illustration uniquement. Veuillez vous reporter au produit réel pour référence.

Caractéristiques

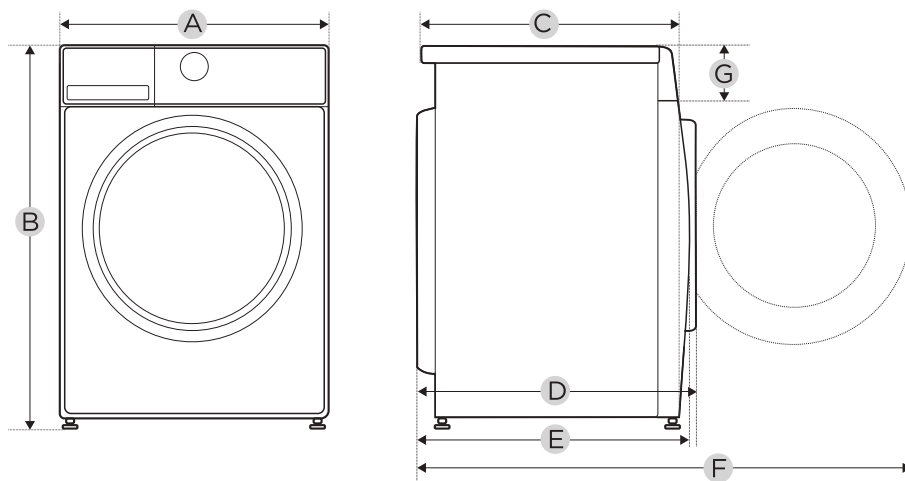

Modèle : **981282 - WF 510 D W566C**

Alimentation électrique : 220-240 V~, 50 Hz

MAX. Courant : 10A

Pression d'eau standard : 0,05 MPa ~ 1 MPa

Capacité de lavage : 5,0 kg

Dimension

A : 595 mm

B : 850 mm

C : 435 mm

Poids : 52 kg

Puissance nominale : 2 000 W

Dimensions de référence

D : 440 mm

E : 400 mm

F : 900 mm

G : 156 mm

Installation

Outils nécessaires si vous effectuez l'installation vous-même (non fournis)

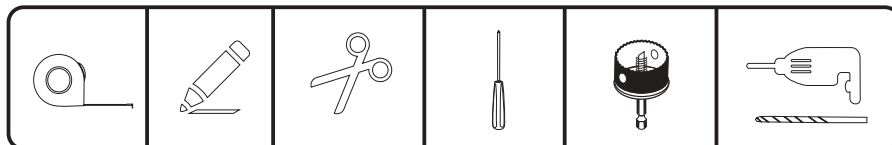

Zone d'installation

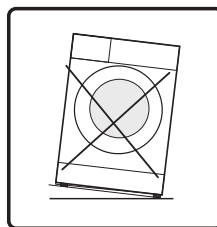
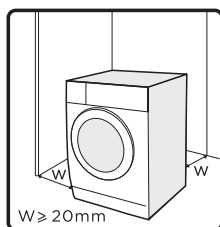

Avertissement !

- Il est important que le produit soit stable, car cela l'empêchera de se déplacer !
- Assurez-vous que la machine soit debout, droite et stable.
- Veillez à ce que le produit ne soit pas placé sur son cordon d'alimentation.
- Assurez-vous de respecter les distances minimales entre le produit et les murs, telles qu'indiquées sur l'image.

Avant d'installer la machine, sélectionnez un emplacement conforme aux exigences suivantes :

- À la surface ferme, sèche et plane.
- Non exposé à la lumière directe du soleil.
- Suffisamment aéré.
- Dans une pièce dont la température est supérieure à 5°C.
- Éloigné de sources de chaleur telles que des appareils à combustion fonctionnant au gaz ou au charbon.

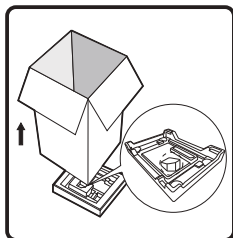
Déballage du lave-linge**Avertissement !**

- Les matériaux d'emballage (par ex. : films protecteurs, polystyrène) peuvent représenter un danger pour les enfants.
- Il existe un risque d'étouffement ! Veillez à ce que tous les éléments d'emballage restent hors de portée des enfants.

1. Retirez le carton d'emballage et les éléments en polystyrène.
2. Retirez la machine en la soulevant et retirez l'emballage de la base.
3. Retirez le ruban adhésif fixant le cordon d'alimentation et le tuyau de vidange.
4. Retirez le tuyau d'arrivée du tambour.

Retirer les vis de transport**Avertissement !**

- Vous devez retirer les vis de transport au dos du produit avant de l'utiliser.

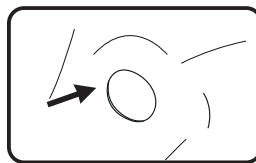
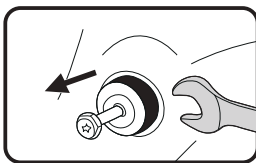
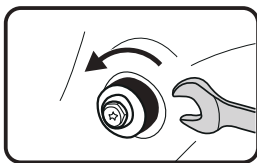

1. Desserrez les 4 vis de transport à l'aide d'une clé.
2. Retirez les vis avec les pièces en caoutchouc et conservez-les pour une utilisation ultérieure.
3. Couvrez les orifices avec les couvercles.

Mise à niveau du lave-linge**Avertissement !**

- Les écrous de verrouillage des quatre pieds doivent être serrés fermement contre la paroi.

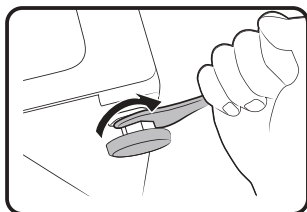

1. Desserrez l'écrou de verrouillage.
2. Faites tourner le pied jusqu'à ce qu'il atteigne le sol.
3. Réglez les pieds et serrez les écrous à l'aide d'une clé. Veillez à ce que la machine soit droite en utilisant un niveau à bulles.

Raccord du tuyau d'arrivée d'eau



Avertissement !

Pour éviter une fuite ou des dégâts des eaux, suivez les instructions de ce chapitre.

- Ne pliez pas, n'écrasez pas et ne modifiez pas le tuyau d'arrivée d'eau.

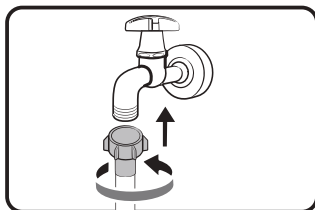
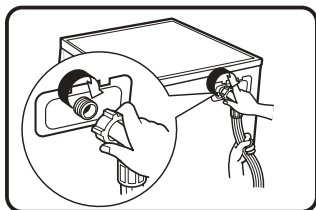

Raccordez le tuyau d'arrivée d'eau à la vanne d'arrivée d'eau et à un robinet d'eau froide comme indiqué.



Remarque :

- Le raccordement doit se faire manuellement, sans outils. Vérifiez que les raccords sont étanches.

Tuyau d'évacuation d'eau



Avertissement !

- Ne pliez pas et ne tirez pas le tuyau de vidange.
- Placez correctement le tuyau de vidange pour éviter des dégâts liés à une fuite d'eau.
- Il n'est pas permis de retirer la boucle du tuyau de vidange.

Le tuyau de vidage peut être positionné de deux manières différentes :

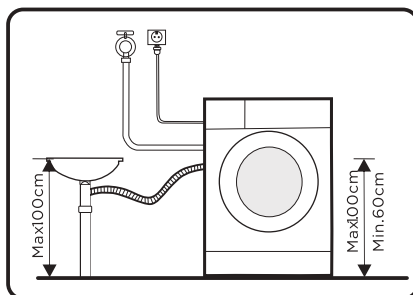
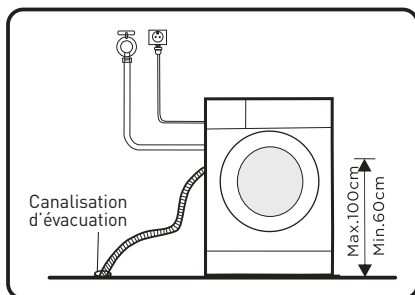

1. Placez-le dans la canalisation d'évacuation des eaux usées.
2. Raccordez-le au tuyau de branchement de la canalisation d'évacuation des eaux usées.

Mousse acoustique



Remarque :

- Veillez à assembler la mousse acoustique, qui peut réduire de manière efficace le bruit causé par la machine en fonctionnement et ainsi offrir un environnement de vie plus calme et plus paisible.

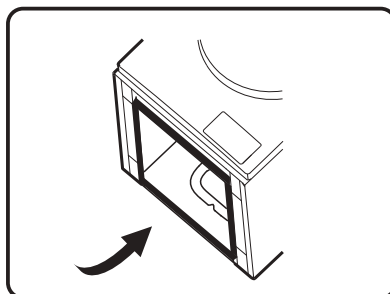
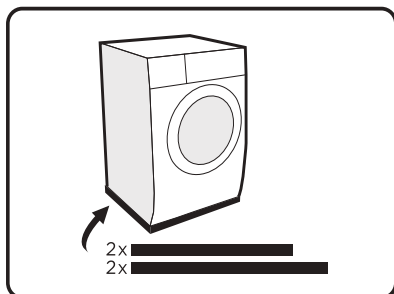

1. Couchez la machine au sol, en la protégeant grâce à un matériau souple posé sur le sol, comme de la mousse ou des vêtements.
2. Collez les 2 bandes de mousse plus longues sur les rebords plus longs de la machine, et les 2 bandes plus courtes sur les rebords plus courts.

Fonctionnement

Démarrage rapide



Attention !

- Avant toute utilisation, assurez-vous que le lave-linge est correctement installé.
- Votre appareil a fait l'objet d'une inspection minutieuse avant son départ de l'usine. Pour éliminer toute eau résiduelle et toute odeur potentielle, il est recommandé de nettoyer l'appareil avant la première utilisation. Il est ainsi conseillé de nettoyer le tambour intérieur en lançant le programme « Nettoyage du tambour » ou tout autre programme pour lequel il est possible de choisir une température de 90 °C. Veillez à ne pas placer de linge ni de lessive dans la machine.

• Avant l'utilisation

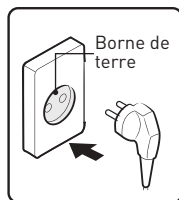

①

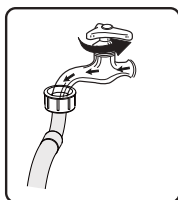

②

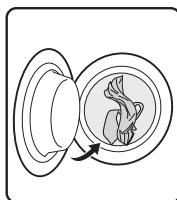

③



④

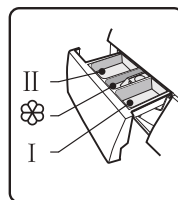

⑤

1. Brancher
2. Ouvrir le robinet
3. Charger
4. Fermer la porte
5. Ajouter la lessive



Remarque :

- Il faut ajouter la lessive dans le compartiment I si la fonction de pré-lavage est sélectionnée.

- **Lavage**

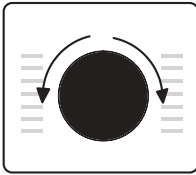

①

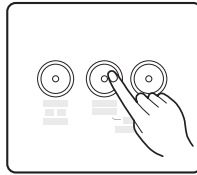

②

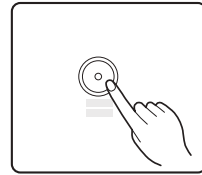

③

1. Choisir un programme
2. Choisir une fonction ou conserver les réglages par défaut
3. Appuyez sur Démarrer/Pause pour lancer le programme

**Remarque :**

1. Si les réglages par défaut sont sélectionnés, l'étape 2 peut être ignorée.
2. Le schéma d'utilisation des boutons de fonction n'est fourni qu'à titre indicatif, veuillez vous reporter à l'appareil.

- **Après le lavage**

La sonnerie retentit.

Avant chaque lavage

- La température ambiante doit être comprise entre 5 et 40 °C pour utiliser la machine. Si elle est utilisée à une température inférieure à 0 °C, la vanne d'arrivée d'eau et le système de vidange pourraient être endommagés. Si la machine est installée dans des conditions glaciales, elle doit être transférée dans un endroit à la température ambiante normale pour que le tuyau d'arrivée d'eau et le tuyau de vidange puisse dégeler avant l'utilisation.
- Veuillez vérifier les étiquettes d'entretien de votre linge et les consignes d'utilisation de votre lessive avant de commencer un lavage. Utilisez des lessives non moussantes ou peu moussantes adaptées aux lave-linge de façon correcte.

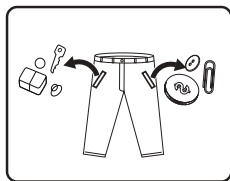

①

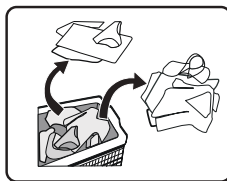

②

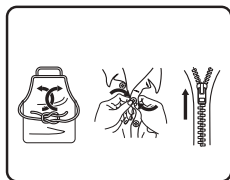

③

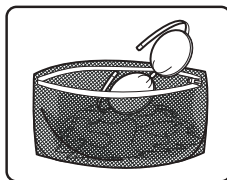



④

1. Retirer tous les objets des poches
2. Trier le linge en fonction des couleurs et du type de textile
3. Nouer les longues bandes de textile et les ceintures, fermer les fermetures éclair et les boutons
4. Placer les petits articles dans un sac à linge

**Avertissement !**

- Ne lavez pas d'articles ayant été nettoyés, lavés, trempés dans des substances combustibles ou explosives comme de la cire, du pétrole, de la peinture, de l'essence, de l'alcool du kérosène et d'autres matériaux inflammables, ou qui en ont été aspergés.
- Laver un seul article peut facilement créer un déséquilibre. Il est donc conseillé d'ajouter un ou deux articles supplémentaires pour les laver ensemble, afin de permettre un essorage fluide.
- Ne lavez pas, n'essorez pas et ne séchez pas de housses de siège, tapis ou vêtements imperméables.

Bac à lessive

- I Prélavage
- II Lavage principal
-  Adoucissant
-  Bouton de déblocage permettant de retirer le bac

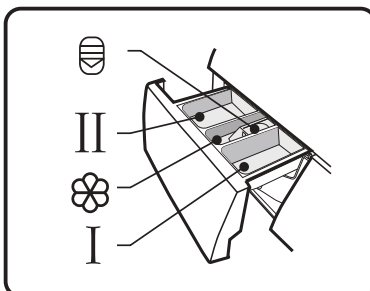

Attention !

- Il ne faut ajouter de lessive dans le « compartiment I » qu'après avoir sélectionné la fonction de prélavage.
- Ne placez pas de billes de lavage dans le bac à lessive.

Panneau de commande

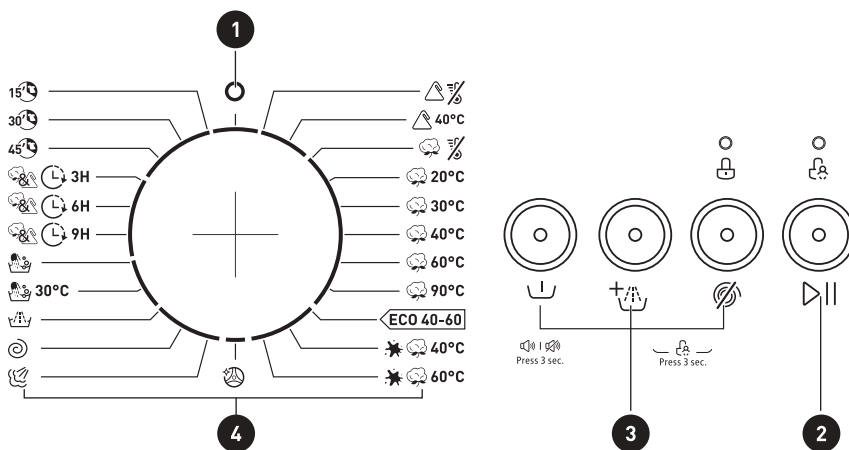
**1 ARRÊT**

Pour mettre l'appareil en marche et hors tension.

2 Démarrer/Pause

























Pour démarrer le programme ou le mettre en pause.

3 Options

Pour sélectionner une fonction supplémentaire. Ce bouton s'allumera une fois sélectionné.

4 Programmes

Programmes disponibles à la sélection selon le type de linge.

Programme	I	II/0	
 Synthétiques	<input type="radio"/>	<input checked="" type="radio"/>	<input type="radio"/>
 Synthétiques 40 °C	<input type="radio"/>	<input checked="" type="radio"/>	<input type="radio"/>
 Lavage à froid	<input type="radio"/>	<input checked="" type="radio"/>	<input type="radio"/>
 Lavage à froid 20 °C	<input type="radio"/>	<input checked="" type="radio"/>	<input type="radio"/>
 Coton 30 °C	<input type="radio"/>	<input checked="" type="radio"/>	<input type="radio"/>
 Coton 40°C	<input type="radio"/>	<input checked="" type="radio"/>	<input type="radio"/>
 Coton 60°C	<input type="radio"/>	<input checked="" type="radio"/>	<input type="radio"/>
 Coton 90°C	<input type="radio"/>	<input checked="" type="radio"/>	<input type="radio"/>
 ÉCO 40-60		<input checked="" type="radio"/>	<input type="radio"/>
 Coton intensif 40 °C		<input checked="" type="radio"/>	<input type="radio"/>
 Coton intensif 60 °C		<input checked="" type="radio"/>	<input type="radio"/>
 Nettoyage du tambour			<input type="radio"/>
 Lavage avec vapeur		<input checked="" type="radio"/>	<input type="radio"/>
 Essorage Seul			
 Rinçage et Essorage			<input type="radio"/>
 Délicat 30 °C		<input checked="" type="radio"/>	<input type="radio"/>
 Délicat		<input checked="" type="radio"/>	<input type="radio"/>
 Fin dans 9 h		<input checked="" type="radio"/>	<input type="radio"/>
 Fin dans 6 h		<input checked="" type="radio"/>	<input type="radio"/>
 Fin dans 3 h		<input checked="" type="radio"/>	<input type="radio"/>
 Lavage rapide 45'		<input checked="" type="radio"/>	<input type="radio"/>
 Lavage rapide 30'		<input checked="" type="radio"/>	<input type="radio"/>
 Lavage rapide 15'		<input checked="" type="radio"/>	<input type="radio"/>

● Signifie Obligatoire ○ Signifie Optionnel

Recommandations en matière de lessive

Lessive recommandée	Type de linge et textile	Programmes de lavage	Temp. de lavage °C
Lessive puissante avec agents de blanchiment et azurants optiques	Linge blanc composé de coton ou lin résistant aux températures élevées	Coton, ÉCO 40-60	30/40/60/90
Lessive pour couleurs sans agents de blanchiment ni azurants optiques	Lessive colorée composée de coton ou lin	Coton, ÉCO 40-60, Lavage à froid	Froid/20/30/40/60/90
Lessive pour couleurs ou douce sans azurants optiques	Lessive colorée composée de fibres à entretien facile ou de matériaux synthétiques	Lavage à froid, synthétiques	Froid/20/40
Lessive douce	Textiles délicats, soie, viscose	Synthétiques	Froid/40



Remarque :

- La lessive ou les additifs agglomérants ou fibreux peuvent être dilués dans de l'eau avant d'être versés dans le bac à lessive, afin d'éviter qu'il ne se bloque et n'entraîne un débordement d'eau.
- Veuillez choisir un type de lessive adapté pour obtenir des performances de lavage maximales avec une consommation d'eau et d'électricité minimale.
- Pour bénéficier de résultats de lavage optimaux, il est important de doser correctement la lessive.
- Utilisez une quantité de lessive réduite si le tambour n'est pas complètement rempli.
- Ajustez toujours la quantité de lessive selon la dureté de l'eau. Si votre eau du robinet est douce, utilisez moins de lessive.
- Choisissez la dose selon le degré de saleté du linge. Des vêtements peu sales nécessitent moins de lessive.
- Les lessives à haute concentration (lessives concentrées) requièrent un dosage particulièrement précis.

Voici les signes d'une quantité de lessive excessive :













- Formation de mousse excessive
- Résultats de lavage et de rinçage médiocres

Voici les signes d'une quantité de lessive insuffisante :

- Linge qui devient gris
- Accumulation de dépôts de calcaire sur le tambour, l'élément chauffant et/ou le linge

Programmes

Les programmes sont disponibles à la sélection selon le type de linge.

Programmes		
	Synthétiques	Pour laver les articles synthétiques, par exemple les chemises, les manteaux et les textiles mélangés. Lors du lavage de textiles tricotés, la quantité de lessive doit être réduite à cause de leur structure moins dense entraînant une formation accrue de mousse.
	Lavage à froid	Pour laver le linge à froid.
	Coton	Textiles robustes, textiles résistant à la chaleur composés de coton ou de lin.
	ÉCO 40-60	Pour laver du linge en coton normalement sale, pouvant être lavé à 40 °C ou à 60 °C, au cours d'un même cycle.
	Coton intensif	Pour améliorer les effets de lavage. Le temps de lavage est augmenté.
	Nettoyage du tambour	Ce programme utilise une stérilisation à une température s'élevant à 90 °C pour rendre le lavage des vêtements plus écologique. Ce programme ne peut pas être lancé avec des vêtements ou autre type de linge. L'effet nettoyant sera plus efficace dans le tambour si une quantité adaptée d'agent de blanchiment au chlore. L'utilisateur peut utiliser ce programme régulièrement selon ses besoins.
	Lavage avec vapeur	Lors du lavage avec vapeur, la vapeur pénètre en profondeur dans les fibres, éliminant de façon efficace les germes et les bactéries, ce qui empêche la formation d'odeurs et protège votre santé.
	Essorage Seul	Pour essorer et évacuer l'eau.
	Rinçage et essorage	Pour rincer et essorer le linge, puis évacuer l'eau.
	Délicat	Pour les textiles délicats lavables, comme par exemple ceux faits de soie, satin, fibres synthétiques ou tissus mélangés.
	Fin dans	Cette fonction peut être activée pour ce programme. La durée totale inclut le temps de lavage et le décalage de la fin du programme, qui peut être de 3 h, 6 h ou 9 h.
	Lavage rapide	Convient pour laver rapidement des articles peu nombreux et peu sales. Le temps de lavage est de 15', 30' ou 45'.























B

Utilisation de l'appareil



Remarque :

- Reportez-vous à votre appareil pour la sélection des programmes.

Programme	Charge (kg)	Durée affichée
	5,0	5,0
 Synthétiques	2,5	2:20
 Synthétiques 40 °C	2,5	2:20
 Lavage à froid	5,0	1:00
 Lavage à froid 20 °C	5,0	1:01
 Coton 30 °C	5,0	2:40
 Coton 40°C	5,0	2:40
 Coton 60°C	5,0	2:45
 Coton 90°C	5,0	2:50
 ÉCO 40-60	5,0	3:08
 Coton intensif 40 °C	5,0	3:48
 Coton intensif 60 °C	5,0	3:53
 Nettoyage du tambour	--	1:18
 Essorage Seul	5,0	0:12
 Lavage avec vapeur	2,5	1:27
 Rinçage et Essorage	5,0	0:20
 Délicat 30 °C	2,0	0:50
 Délicat	2,0	0:48
 Fin dans 9 h	5,0	0:59
 Fin dans 6 h	5,0	0:59
 Fin dans 3 h	5,0	0:59
 Lavage rapide 45'	2,0	0:45
 Lavage rapide 30'	2,0	0:30
 Lavage rapide 15'	2,0	0:15

**Remarque :**

- Les paramètres indiqués dans ce tableau ne sont fournis qu'à titre indicatif. Les réglages réels peuvent différer des paramètres indiqués dans le tableau ci-dessus.

WF 510 D W566C							
Programme	Capacité nominale en kg	Réglage de la température	Durée du programme en h:min	Consommation d'énergie en kWh/programme	Consommation d'eau en l/programme	Température de lavage la plus élevée °C ⁽¹⁾	Humidité résiduelle en %/vitesse d'essorage ⁽²⁾
Synthétiques	2,5	Froid	2:20	0,327	50	Froid	65 %/1 000
Lavage à froid 20 °C	2,5	20	1:01	0,201	34	20	65 %/1 000
Coton 60°C	5,0	60	2:45	1,175	51	60	70 %/1 000
ÉCO 40-60 ⁽³⁾	5,0	–	3:08	0,769	46,0	37	71,9 %/1 000
	2,5	–	2:30	0,485	37,0	31	71,9 %/1 000
	1,5	–	2:30	0,368	34,0	28	71,9 %/1 000
Coton intensif 40 °C	5,0	40	3:48	0,994	51	40	65 %/1 000
Lavage rapide 15'	2,0	Froid	0:15	0,035	31	Froid	75 %/800

- Les données mentionnées ci-dessus sont fournies à titre de référence uniquement et peuvent changer selon les conditions d'utilisation réelles.
- Les données fournies pour les programmes autres que le programme ÉCO 40-60 ne sont données qu'à titre d'indication.
- Le programme Lavage à froid 20 °C permet de laver le linge en coton légèrement sale à une température nominale de 20 °C, conformément au règlement (UE) 2019/2023.
- Conforme à la norme EN 60456:2016+A11:2020 et (UE) 2019/2014, (UE) 2019/2023, (UE) 2021/340, (UE) 2021/341.

La classe d'efficacité énergétique européenne est : S
 Programme pour le test d'énergie : ÉCO 40-60. Autre comme programme par défaut.
 Demi-charge pour une machine de 5,0 kg : 2,5 kg.
 Quart de charge pour une machine de 5,0 kg : 1,5 kg.

- ⁽¹⁾ La température la plus élevée atteinte par le linge durant le cycle de lavage pendant au moins 5 minutes.
- ⁽²⁾ Humidité résiduelle après le cycle de lavage, en pourcentage de teneur en eau et la vitesse d'essorage à laquelle ce résultat est produit.
- ⁽³⁾ Le programme ÉCO 40-60 est capable de laver du linge en coton normalement sale, pouvant être lavé à 40 °C ou à 60 °C, au cours d'un même cycle. Ce programme est utilisé pour évaluer la conformité au règlement (UE) 2019/2023.

Les programmes les plus efficaces en termes de consommation énergétiques sont généralement ceux qui utilisent des températures plus basses et durent plus longtemps.

Charger un lave-linge domestique jusqu'à la capacité indiquée pour les programmes respectifs contribuera à économiser de l'eau et de l'électricité.





Le bruit et la teneur en humidité restante dépendent de la vitesse d'essorage : plus la vitesse d'essorage est élevée pendant l'essorage, plus le bruit sera élevé et moins il y aura d'humidité restante.



Attention !



















- En cas de coupure de courant pendant l'utilisation de l'appareil, le programme sélectionné reste dans sa mémoire. La machine reprendra le programme une fois le courant rétabli.

Options

Programme	Temp. par défaut (°C)	Vitesse d'essorage par défaut (tr/min)	Fonctions supplémentaires
 Synthétiques	Froid	1 000	Prélavage, Rinçage Plus, Pas d'essorage
 Synthétiques 40 °C	40	1 000	Prélavage, Rinçage Plus, Pas d'essorage
 Lavage à froid	Froid	1 000	Prélavage, Rinçage Plus, Pas d'essorage
 Lavage à froid 20 °C	20	1 000	Prélavage, Rinçage Plus, Pas d'essorage
 Coton 30 °C	30	1 000	Prélavage, Rinçage Plus, Pas d'essorage

B

Utilisation de l'appareil

 40°C	Coton 40°C	40	1 000	Prélavage, Rinçage Plus, Pas d'essorage
 60°C	Coton 60°C	60	1 000	Prélavage, Rinçage Plus, Pas d'essorage
 90°C	Coton 90°C	90	1 000	Prélavage, Rinçage Plus, Pas d'essorage
 ECO 40-60	ÉCO 40-60	--	1 000	
 40°C	Coton intensif 40 °C	40	1 000	Pas d'essorage
 60°C	Coton intensif 60 °C	60	1 000	Pas d'essorage
	Nettoyage du tambour	90	--	
	Lavage avec vapeur	40	1 000	Rinçage Plus, Pas d'essorage
	Essorage Seul	-	1 000	Pas d'essorage
	Rinçage et essorage	-	1 000	Rinçage Plus, Pas d'essorage
 30°C	Délicat 30 °C	30	600	Rinçage Plus, Pas d'essorage
	Délicat	Froid	600	Rinçage Plus, Pas d'essorage
 9H	Fin dans 3 h/6 h/9 h	40	1 000	
 6H				
 3H				
 45'	Lavage rapide 45'	40	800	Pas d'essorage
 30'	Lavage rapide 30'	30	800	Pas d'essorage
 15'	Lavage rapide 15'	Froid	800	Pas d'essorage

**Remarque :**

- Pour connaître la vitesse d'essorage maximale, la durée du programme et d'autres détails du programme ÉCO 40-60, veuillez vous reporter au contenu de la page de la fiche produit.
- Le tableau indique les options pouvant être réglées pour chaque programme. Il indique aussi si un réglage n'est pas disponible pour un programme.

**Pré lavage**

La fonction Pré lavage permet d'effectuer un lavage supplémentaire avant le lavage principal et convient au lavage de la poussière à la surface des vêtements. Il faut placer de la lessive dans le compartiment (I) lorsque le pré lavage est sélectionné.

**Rinçage Plus**

Cette fonction ajoute un rinçage supplémentaire du linge quand cette fonction est sélectionnée.

**Pas d'essorage**

Aucun essorage ne sera effectué lorsque cette fonction est sélectionnée.

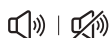
**Désactivation de la sonnerie**

Choisir un programme



Appuyer sur le bouton [Pré lavage] pendant 3 secondes : la sonnerie est désactivée.

Pour réactiver la fonction de sonnerie, appuyez à nouveau pendant 3 secondes sur ces boutons. Ce réglage sera conservé jusqu'à la prochaine réinitialisation.

**Attention !**

- Une fois la sonnerie désactivée, toutes les alertes sonores de l'appareil sont désactivées.

**Verrou enfant**

Permet d'éviter toute action accidentelle par des enfants.



Choisir un programme



Démarrer



Press 3 sec.

Appuyer sur [Rinçage Plus] et [Pas d'essorage] pendant 3 secondes jusqu'à ce que la sonnerie retentisse.

**Attention !**

- Le « Verrou enfant » ne peut être désactivé qu'en appuyant sur ces deux boutons. Ce « Verrou enfant » verrouillera tous les boutons à l'exception du bouton marche/arrêt et du bouton « Verrou enfant », même lorsque vous éteignez l'appareil, le mettez hors tension ou lorsque le programme se termine.
- Désactivez le « Verrou enfant » avant de choisir un programme et de le démarrer.

**Remarque :**

Compteur d'utilisations

1. Débranchez l'appareil pendant 10 secondes, puis rebranchez-le.
2. Mettez-le en marche et, dans les 10 secondes, appuyez en même temps sur les boutons « Prélavage » et « Pas d'essorage » sur le panneau de commande, en les maintenant appuyés pendant environ 5 secondes jusqu'à ce que la sonnerie retentisse.
3. Le nombre de fois que le voyant clignote représente le nombre d'utilisations de la machine. Par exemple, si la machine a été utilisée 3 456 fois, « Prélavage » clignotera 3 fois ; « Rinçage Plus » clignotera 4 fois, « Pas d'essorage » clignotera 5 fois ; « Démarrer/Pause » clignotera 6 fois.
4. Procédez à nouveau à l'étape 1. L'utilisateur peut alors utiliser l'appareil normalement.

Nettoyage et entretien



Avertissement !

- Débranchez toujours l'appareil et fermez le robinet d'eau avant d'effectuer une opération de nettoyage ou d'entretien.

Nettoyage du corps de l'appareil

L'entretien correct du lave-linge permet de prolonger sa durée de vie. Ses surfaces peuvent être nettoyées avec du détergent neutre non abrasif dilué, si nécessaire. En cas de débordement d'eau, essuyez-la immédiatement avec un torchon.

N'utilisez jamais d'objets pointus pour nettoyer l'appareil.

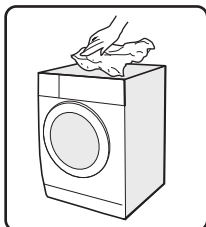

Attention !

- N'utilisez jamais de produits abrasifs ou caustiques, d'acides formiques ou de solvants dérivés dilués ni de substances similaires, comme de l'alcool ou des produits chimiques.

Nettoyage du tambour

Toute tache de rouille laissée dans le tambour par les articles métalliques doit être enlevée immédiatement à l'aide de détergent non chloré. N'utilisez jamais de paille de fer pour nettoyer le tambour !

**Remarque :**

- Gardez le linge à l'écart de la machine lorsque vous nettoyez le tambour.

Nettoyage du joint de porte et du hublot

Essuyez le hublot et le joint après chaque lavage pour retirer les peluches et les taches. Une accumulation de peluches peut entraîner des fuites.

Retirez pièces, boutons et autres objets du joint après chaque lavage.

Nettoyez le joint de porte et le hublot tous les mois pour garantir le bon fonctionnement de l'appareil.

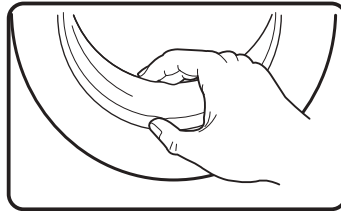
**Nettoyage du filtre d'arrivée****Remarque :**

- Un flux d'eau réduit indique que le filtre doit être nettoyé.

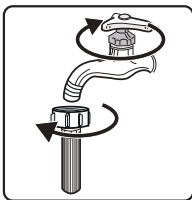

①

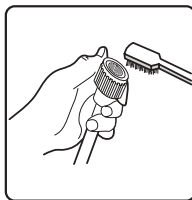

②

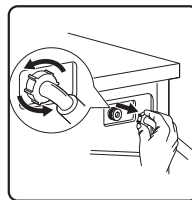

③

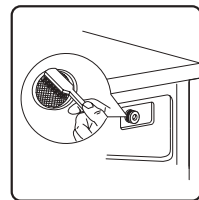

④

1. Fermez le robinet d'eau et déconnectez-en le tuyau d'arrivée d'eau.
2. Nettoyez le filtre à l'aide d'une brosse.
3. Dévissez le tuyau d'arrivée d'eau du dos de la machine. Sortez le filtre avec une pince à long bec.

4. Nettoyez le filtre à l'aide d'une brosse.
5. Remettez le filtre en place au niveau de l'arrivée d'eau et raccordez à nouveau le tuyau d'arrivée d'eau.
6. Nettoyez le filtre d'arrivée tous les 3 mois pour garantir le bon fonctionnement de l'appareil.

Nettoyage du bac à lessive

1. Appuyez sur le bouton de déblocage [🔓] du couvercle de l'adoucissant, puis sortez le bac à lessive du logement. Nettoyez l'intérieur du logement à l'aide d'une brosse.
2. Soulevez le couvercle de l'adoucissant pour le sortir du bac à lessive et nettoyez le couvercle et le bac à l'eau.
3. Remettez le couvercle de l'adoucissant en place et insérez à nouveau le bac dans le logement.

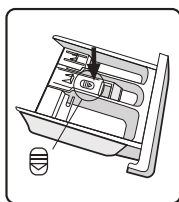

①

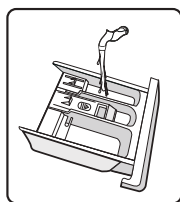

②

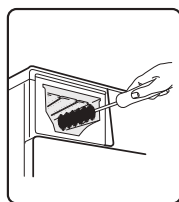

③

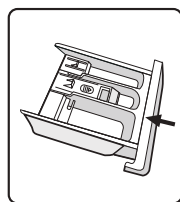

④

1. Appuyez sur le bouton de déblocage et retirez le bac.
2. Nettoyez le bac à lessive et le couvercle de l'adoucissant à l'eau.
3. Nettoyez l'intérieur du logement à l'aide d'une brosse douce.
4. Insérez le bac à lessive.



Remarque :

- N'utilisez pas de produits abrasifs ou caustiques pour nettoyer les pièces en plastique.
- Nettoyez le bac à lessive tous les 3 mois pour garantir le bon fonctionnement de l'appareil.

Nettoyage du filtre de la pompe de vidange



Avertissement !

- Assurez-vous que le programme de lavage est terminé et que la machine est vide. Éteignez la machine et débranchez-la avant de nettoyer le filtre de la pompe de vidange.
- Faites attention à l'eau chaude. Attendez que l'eau refroidisse. Risque de brûlure !
- Nettoyez le filtre périodiquement tous les 3 mois pour garantir le bon fonctionnement du lave-linge.

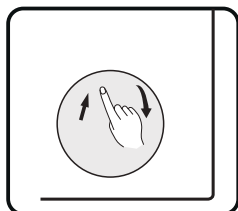

①

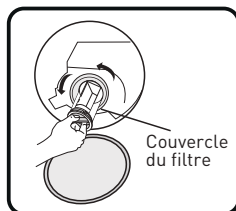

②

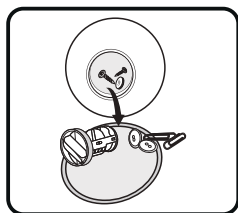

③

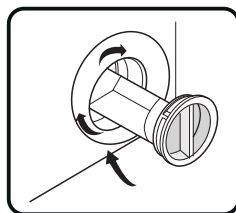

④

1. Ouvrez le couvercle inférieur.
2. Ouvrez le filtre en tournant dans le sens des aiguilles d'une montre.
3. Retirez les corps étrangers.
4. Fermez le couvercle inférieur.



Attention !

- Quand l'appareil est cours d'utilisation et selon le programme sélectionné, il peut y avoir de l'eau chaude dans la pompe. Ne retirez jamais le couvercle de la pompe pendant un programme de lavage. Attendez toujours que l'appareil ait terminé le programme et soit vide. Assurez-vous de serrer fermement le couvercle lorsque vous le remettez en place.

Dépannage

En cas de problème avec l'appareil, vérifiez s'il est possible de le résoudre à l'aide des tableaux ci-dessous.

Description	Cause possible	Solution
L'appareil ne se met pas en marche.	<ul style="list-style-type: none"> • La porte n'est pas correctement verrouillée. • Des articles sont coincés dans la porte. 	<ul style="list-style-type: none"> • Fermez correctement la porte et recommencez. • Vérifiez le linge.
Impossible d'ouvrir la porte.	<ul style="list-style-type: none"> • La protection de sécurité est activée. 	<ul style="list-style-type: none"> • Débranchez l'appareil de la prise électrique et remettez-le en marche.
Il y a une fuite d'eau.	<ul style="list-style-type: none"> • Les raccords ne sont pas étanches. 	<ul style="list-style-type: none"> • Inspectez le tuyau d'arrivée d'eau et resserrez-le. • Vérifiez et nettoyez le tuyau de vidange.
Il y a des résidus de lessive dans le bac à lessive.	<ul style="list-style-type: none"> • La lessive est humide et/ou coagulée. 	<ul style="list-style-type: none"> • Nettoyez le bac à lessive et séchez-le en l'essuyant.
Les voyants ou l'écran ne fonctionnent pas.	<ul style="list-style-type: none"> • Problèmes de connexion au niveau du circuit imprimé ou du faisceau de fils. 	<ul style="list-style-type: none"> • Éteignez l'alimentation et vérifiez si la fiche d'alimentation est correctement branchée.

Description	Cause possible	Solution
Bruit anormal	<ul style="list-style-type: none"> Les vis de blocage sont toujours en place. Le sol n'est pas ferme ni plat. 	<ul style="list-style-type: none"> Vérifiez que les vis de blocage ont été retirées. Assurez-vous que l'appareil est installé sur un sol ferme et plat.

Codes d'erreur

Code d'erreur	Description	Cause possible	Solution
E1	Prélavage		
E2	Rincage Plus		
E3	Pas d'essorage		
E4	Démarrer/Pause		
E5	Clignotement	<ul style="list-style-type: none"> La porte n'est pas correctement verrouillée. 	<ul style="list-style-type: none"> Redémarrez l'appareil après avoir fermé la porte. Vérifiez si des vêtements sont coincés.
E6	Clignotement	<ul style="list-style-type: none"> Problème d'injection d'eau pendant le lavage. 	<ul style="list-style-type: none"> Vérifiez si la pression de l'eau est trop basse. Redressez le tuyau d'eau. Vérifiez si le filtre de la vanne d'arrivée d'eau est bouché.
E7	Clignotement	<ul style="list-style-type: none"> Temps de vidange de l'eau excessif. 	<ul style="list-style-type: none"> Vérifiez si le tuyau de vidange est bloqué.
E8	Clignotement	<ul style="list-style-type: none"> Débordement d'eau. 	<ul style="list-style-type: none"> Remettez le lave-linge en marche.
E9	Clignotement	<ul style="list-style-type: none"> Divers 	<ul style="list-style-type: none"> D'abord, essayez à nouveau, puis contactez l'assistance technique si le problème persiste.

Transport

ÉTAPES IMPORTANTES LORS DU TRANSPORT DE L'APPAREIL

- Débranchez l'appareil et fermez le robinet d'arrivée d'eau.
- Vérifiez que la porte et le bac à lessive sont bien fermés.
- Retirez le tuyau d'arrivée d'eau et le tuyau de vidange des installations domestiques.

- Laissez l'appareil se vider complètement de l'eau restante (voir le chapitre « Nettoyage du filtre de la pompe de vidange »).
- Important : Remettez les 4 vis de transport en place au dos de l'appareil.
- Cet appareil est lourd. Transportez-le avec précaution. Ne tenez jamais une pièce saillante de la machine lorsque vous la soulevez. La porte de l'appareil ne doit pas être utilisée comme une poignée.

Fiche produit

Nom du fournisseur ou marque de commerce^{(a),(c)} :

Adresse du fournisseur^{(a),(c)} :

Identifiant du modèle^(a) : WF 510 D W566C

Paramètres généraux du produit :

Paramètre	Valeur		Paramètre	Valeur	
Capacité nominale ^(b) (kg)	5,0		Dimensions en cm ^{(a),(c)}	Taille	85
				Largeur	60
				Profondeur	40
Classe d'efficacité énergétique (EEI _w) ^(b)	79,9		Classe d'efficacité énergétique ^(b)	D ^(d)	
Indice d'efficacité de lavage ^(b)	1,031		Efficacité du rinçage (g/kg) ^(b)	5,0	
Consommation électrique en kWh par cycle, basée sur le programme ÉCO 40-60. La consommation électrique réelle dépendra des conditions d'utilisation de l'appareil.	0,602		Consommation d'eau en litres par cycle, basée sur le programme ÉCO 40-60. La consommation d'eau réelle dépendra des conditions d'utilisation de l'appareil et de la dureté de l'eau.	41	
Température maximale à l'intérieur du textile traité ^(b) (°C)	Capacité nominale	37	Teneur en humidité restante pondérée ^(b) (%)	71,9	
	Moitié	31			
	Quart	28			
Vitesse d'essorage ^(b) (tr/min)	Capacité nominale	1 000	Classe d'efficacité d'essorage ^(b)	D ^(d)	
	Moitié	1 000			
	Quart	1 000			
Durée du programme ^(b) (h:min)	Capacité nominale	3:08	Type	Pose libre	
	Moitié	2:30			
	Quart	2:30			

Fiche produit

Émissions de bruit acoustique aérien pendant la phase d'essorage ^(b) (dB(A) re 1 pW)	79	Classe d'émissions de bruit acoustique aérien (phase d'essorage)	C ^(d)
Mode Arrêt (W) (le cas échéant)	0,50	Mode Veille (W) (le cas échéant)	1,00
Départ différé (W) (le cas échéant)	4,00	Veille connectée (W) (le cas échéant)	N/A

Durée minimale de la garantie offerte par le fournisseur^{(a),(c)} :

Ce produit a été conçu pour libérer des ions argent pendant le cycle de lavage.

NON

Informations supplémentaires :

Lien web vers le site Internet du fournisseur, où se trouvent les informations du point 9 de l'annexe II du règlement de la Commission (UE) 2019/2023⁽¹⁾ :

^(a) Ce produit ne doit pas être considéré comme pertinent aux fins de l'article 2(6) du règlement (UE) 2017/1369 ;

^(b) Pour le programme ÉCO 40-60 ;

^(c) Les changements apportés à ces produits ne doivent pas être considérés comme pertinents aux fins du paragraphe 4 de l'article 4 du règlement (UE) 2017/1369 ;

^(d) Si la base de données du produit génère le contenu définitif de cette cellule de façon automatique, le fournisseur ne doit pas entrer ces données.

Bedankt!

Proficiat met uw keuze voor een product van HIGHONE. De selectie en de testen van de toestellen van HIGHONE gebeuren volledig onder controle en supervisie van ELECTRO DEPOT. We staan garant voor de kwaliteit van de toestellen van HIGHONE, die uitmunten in hun eenvoudig gebruik, hun betrouwbare werking en hun onberispelijke kwaliteit.

ELECTRO DEPOT beveelt de HIGHONE toestellen aan en is ervan overtuigd dat u uiterst tevreden zal zijn bij elk gebruik van het toestel. Welkom bij ELECTRO DEPOT.

Bezoek onze website: www.electrodepot.be



60

NL

Inhoudstafel

A

**Overzicht van het
toestel**

Onderdelen
Specificaties

B

**Gebruik van het
toestel**

Installatie
Werking

C

**Reiniging en
onderhoud**

Reiniging en onderhoud
Probleemoplossing
Transport

Productfiche

Onderdelen

A Deur

B Wasmiddellade

C Bedieningspaneel

D Afvoerslang

E Netsnoer

F Serviceklep

G 4x Afdekkappen

H 1 x Toevoerslang koud water

I Akoestische spons (optioneel)



Opmerking:

- De productafbeelding dient alleen ter illustratie, raadpleeg het echte product als referentie.

Specificaties

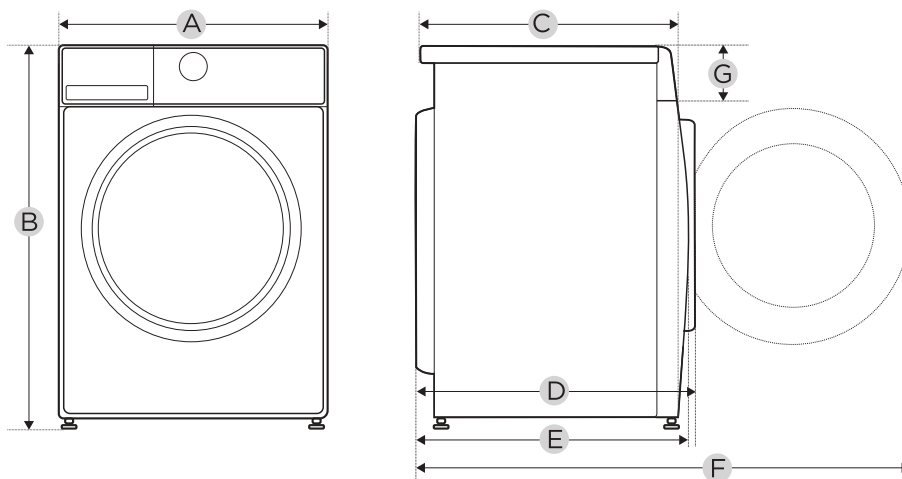

Model: **981282 - WF 510 D W566C**

Voeding: 220-240 V~, 50 Hz

MAX. Stroom: 10A

Standaard waterdruk: 0,05 MPa ~ 1 MPa

Wascapaciteit: 5,0 kg

Afmetingen

A: 595 mm

B: 850 mm

C: 435 mm

Gewicht: 52 kg

Nominaal vermogen: 2 000 W

Referentie-afmetingen

D: 440 mm

E: 400 mm

F: 900 mm

G: 156 mm

Installatie

Gereedschap nodig wanneer u de installatie zelf doet (niet inbegrepen)

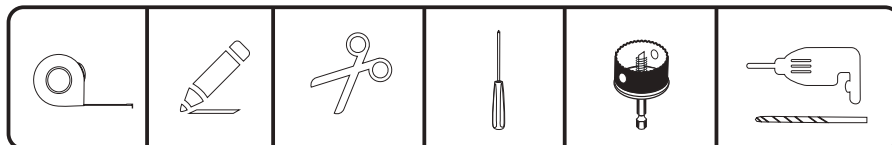

Installatiegebied

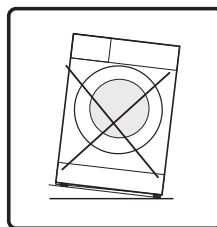
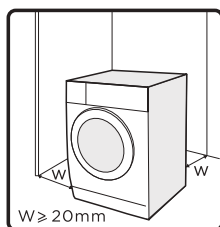

Waarschuwing!

- Stabiliteit is belangrijk om het verschuiven van het product te vermijden!
- Zorg ervoor dat de machine waterpas en stabiel staat.
- Zorg ervoor dat het product niet op het netsnoer staat.
- Zorg ervoor dat u de minimale afstand tot de muur aanhoudt, zoals weergegeven in de afbeelding.

Alvorens de machine te installeren, zoek naar een locatie die aan de volgende eigenschappen voldoet:

- Harde, droge en vlakke ondergrond.
- Vermijd direct zonlicht.
- Voldoende ventilatie.
- Kamertemperatuur is hoger dan 5°C.
- Blijf uit de buurt van warmtebronnen, zoals een apparaat die kool of gas verbrandt.

De wasmachine uitpakken

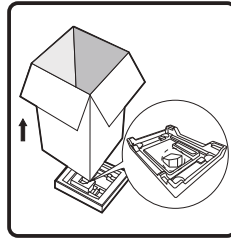

Waarschuwing!

- Verpakkingsmateriaal (bijv. folie, piepschuim) kan gevaarlijk zijn voor kinderen.
- Er bestaat verstikkingsgevaar! Houd alle verpakking uit de buurt van kinderen.

1. Verwijder de kartonnen doos en de piepschuimverpakking.
2. Til de machine op en verwijder de verpakking onderaan.
3. Verwijder de tape waarmee het netsnoer en de afvoer slang zijn vastgemaakt.
4. Haal de toevoerslang uit de trommel.

Transportbouten verwijderen



Waarschuwing!

- Verwijder de transportbouten aan de achterkant alvorens het product te gebruiken.

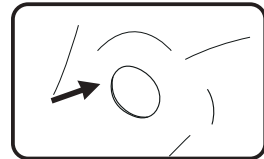
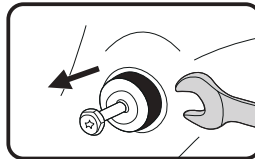
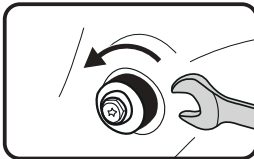

1. Draai de 4 transportbouten los met een steeksleutel.
2. Verwijder de bouten samen met de rubberen delen en bewaar ze voor toekomstig gebruik.
3. Sluit de gaten met de afdekkappen.

De wasmachine waterpas zetten



Waarschuwing!

- De borgmoeren op alle vier de voeten moeten stevig tegen de behuizing worden vastgeschroefd.

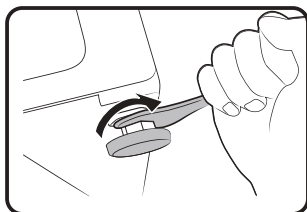

1. Draai de borgmoer los.
2. Draai de voet totdat deze de vloer bereikt.
3. Stel de voeten af en draai de moeren met een steeksleutel vast. Zorg ervoor dat de machine waterpas staat met behulp van een waterpas.

De watertoevoerslang aansluiten



Waarschuwing!

Volg de instructies in dit hoofdstuk om lekkage of waterschade te voorkomen.

- Zorg dat de watertoevoerslang niet wordt geknikt, geplet of aangepast.

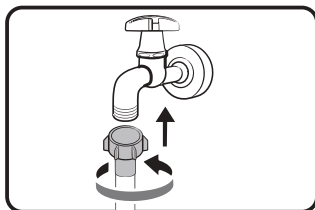
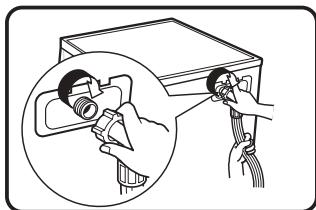

Sluit de watertoevoerslang aan op de waterinlaatklep en een waterkraan met koud water, zoals aangegeven.



Opmerking:

- Sluit handmatig aan en gebruik geen gereedschap. Controleer of de verbindingen stevig zijn vastgemaakt.

Afvoerslang



Waarschuwing!

- De afvoerslang niet knikken of verlengen.
- Plaats de afvoerslang op de juiste manier om schade door waterlekkage te vermijden.
- Het is niet toegestaan om de gesp van de afvoerpijp te verwijderen.

Er zijn twee manieren om het uiteinde van de afvoerslang te plaatsen:

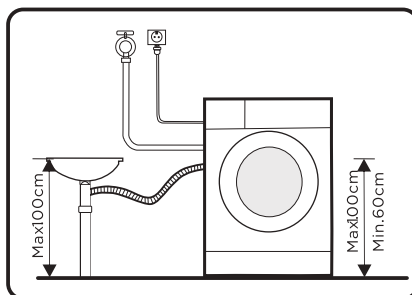
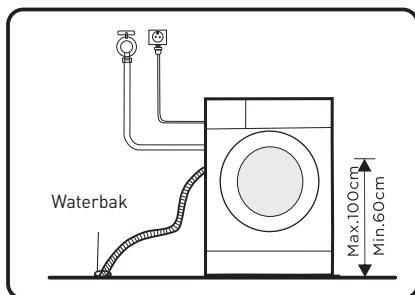

1. Steek de slang in de waterbak.
2. Sluit de slang aan op de afvoerpijp van de bak.

Akoestische sponzen



Opmerking:

- Zorg ervoor dat u de akoestische sponzen aanbrengt, deze verlagen het geluid van de machine tijdens de werking aanzienlijk om u een rustigere en stillere leefomgeving te bieden.

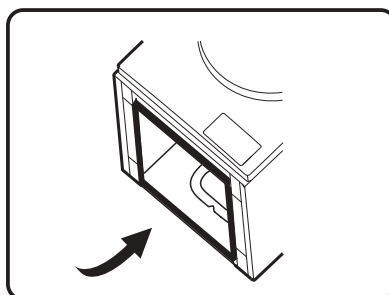
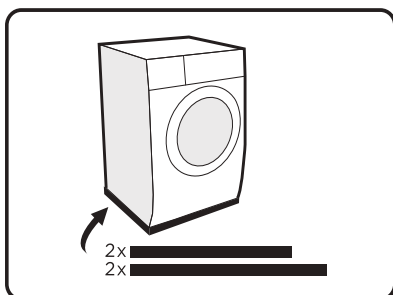

1. Leg de machine op de vloer en breng een zacht materiaal, zoals schuim of doeken, tussen de machine en de vloer aan als bescherming.
2. Plak de 2x langere sponzen op de langere onderste randen van de machine en de 2x kortere sponzen op de kortere onderste randen.

Werking

Snelle start



Voorzichtig!

- Controleer voor het wassen of de wasmachine juist geïnstalleerd is.
- Uw apparaat werd grondig gecontroleerd voordat deze de fabriek heeft verlaten. Om eventueel achtergebleven water te verwijderen en mogelijke geuren te neutraliseren, is het raadzaam om uw apparaat voor het eerste gebruik schoon te maken. Daarom wordt aanbevolen om de binnentrommel te reinigen met 'Trommel reinigen' of een ander programma met de optionele temperatuur van 90 °C. Pas op dat je geen wasgoed en wasmiddel in de machine doet.

• Voor het wassen

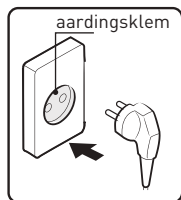

①

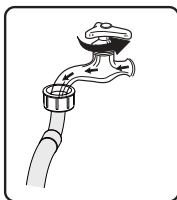

②

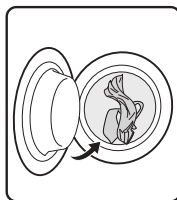

③

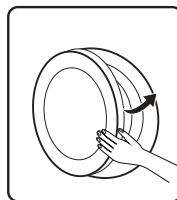

④

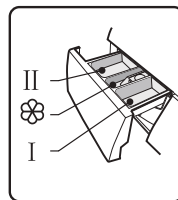

⑤

1. Stekker in stopcontact steken
2. Kraan opendraaien
3. Vullen
4. Deur sluiten
5. Wasmiddel toevoegen



Opmerking:

- Doe wasmiddel in vak I wanneer de voorwasfunctie wordt geselecteerd.

- **Wassen**

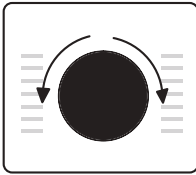

①

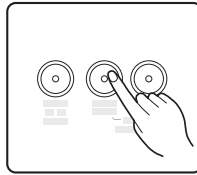

②

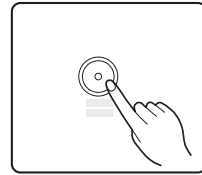

③

1. Programma selecteren
2. Functie selecteren of standaardinstellingen behouden
3. Op Start/Pauze drukken om het programma te starten

**Opmerking:**

1. Als standaard is geselecteerd, kan stap 2 worden overgeslagen.
2. De lijngrafiek van de functieknoppen is alleen ter referentie, raadpleeg het echte product als standaard.

- **Na het wassen**

Zoemer.

Voor elke wasbeurt

- De omgevingstemperatuur van de machine moet tussen 5°C en 40°C zijn. Bij een gebruik onder 0°C kunnen de inlaatklep en het afvoersysteem beschadigd raken. Als de machine onder vorstomstandigheden wordt geïnstalleerd, moet deze eerst worden overgebracht naar een normale omgevingstemperatuur om ervoor te zorgen dat de watertoevoerslang en afvoerslang voor gebruik kunnen ontdooien.
- Controleer voor het wassen de waslabels en de gebruiksinstructies van uw wasmiddel. Gebruik niet- of beperkt schuimend wasmiddel dat geschikt is voor de wasmachine.

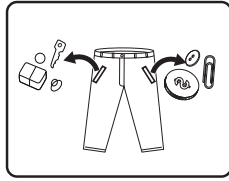

①

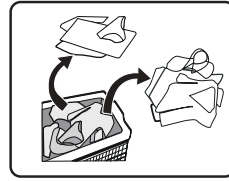

②

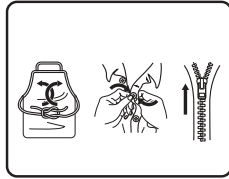

③

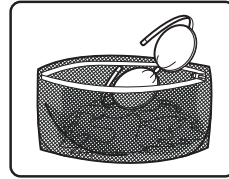

④

1. Alle items uit de zakken halen
2. Het wasgoed op kleur en textielsoort sorteren
3. Lange textielstroken en riemen vastmaken, en ritsen en knopen sluiten
4. Kleine items in een waszak stoppen



Waarschuwing!

- Was geen artikelen die zijn gereinigd, gewassen, gedrenkt in of gedept met brandbare of explosieve stoffen zoals was, olie, verf, benzine, alcohol, kerosine en andere brandbare materialen.
- Het wassen van losse kledingstukken kan eenvoudig een grote excentriciteit creëren.
Daarom wordt het aangeraden om nog een of twee extra stukken wasgoed aan de was toe te voegen zodat het centrifugeren soepel verloopt.
- Was, centrifugeer of droog geen waterdichte zittingen, matten of kleding.

Wasmiddellade

- I Voorwas
- II Hoofdwash
-  Wasverzachter
-  Vrijgaveknop om de lade uit te trekken

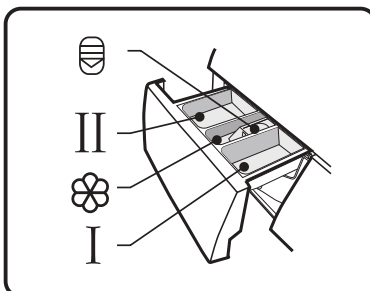

Voorzichtig!

- Doe alleen wasmiddel in vak I nadat de voorwasfunctie is geselecteerd.
- Doe geen waspods in de wasmiddellade.

Bedieningspaneel

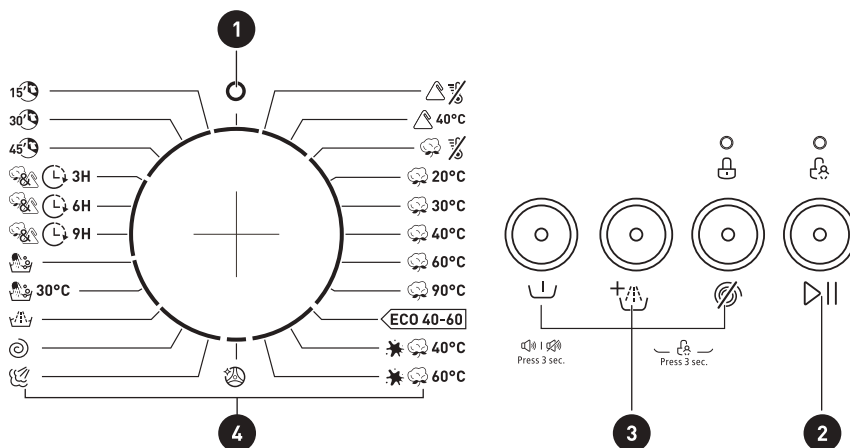

1 UIT

Zet het apparaat aan en uit.

2 Start/Pauze

























Je programma starten of pauzeren.

3 Optie

Hiermee kunt u extra functies selecteren, die branden bij selectie.

4 Programma's

Beschikbaar naargelang het soort wasgoed.

Programma	I	II/△	
 Synthetisch	○	●	○
 Synthetisch 40 °C	○	●	○
 Koud wassen	○	●	○
 Koud wassen op 20°C	○	●	○
 Katoen 30°C	○	●	○
 Katoen 40°C	○	●	○
 Katoen 60°C	○	●	○
 Katoen 90°C	○	●	○
 ECO 40-60		●	○
 Katoen Intensief 40°C		●	○
 Katoen Intensief 60°C		●	○
 Trommel reinigen			○
 Stoomwassen		●	○
 Alleen centrifuge			
 Spoelen+Centrifuge			○
 Delicaat 30°C		●	○
 Delicaat		●	○
 Eindigt over 9u		●	○
 Eindigt over 6u		●	○
 Eindigt over 3u		●	○
 Snel wassen 45'		●	○
 Snel wassen 30'		●	○
 Snel wassen 15'		●	○

● Betekent moet ● Betekent optioneel

Aanbeveling voor soort wasmiddel

Aanbevolen wasmiddel	Soort wasgoed en textiel	Wascycli	Wastemp. ° C
Heavy-duty wasmiddel met bleekmiddel en optisch witmiddel	Witte was van kookvast katoen of linnen	Katoen, ECO 40-60	30/40/60/90
Kleurwasmiddel zonder bleekmiddel en optisch witmiddel	Gekleurd wasgoed van katoen of linnen	Katoen, ECO 40-60, Koud wassen	Koud/20/30/40/60/90
Kleur- of mild wasmiddel zonder optisch witmiddel	Gekleurd wasgoed van onderhoudsvriendelijke vezels of synthetisch materiaal	Koud wassen, Synthetisch	Koud/20/40
Mild wasmiddel	Delicaat stoffen, zijde, viscose	Synthetisch	Koud /40

**Opmerking:**

- Samenklonterd of stroperig wasmiddel of additief kan in een beetje water worden verdund voordat het in de wasmiddellade wordt gegoten, om te voorkomen dat de inlaat verstopt raakt en er water overloopt.
- Kies het geschikte soort wasmiddel voor maximale wasprestaties en minimaal water- en energieverbruik.
- Voor het beste reinigingsresultaat is een juiste dosering van het wasmiddel belangrijk.
- Gebruik minder wasmiddel wanneer de trommel niet helemaal gevuld is.
- Pas de hoeveelheid wasmiddel altijd aan naargelang de waterhardheid. Als uw leidingwater zacht is, gebruik dan minder wasmiddel.
- Doseer afhankelijk van hoe vuil uw wasgoed is, voor minder vuile kleding hebt u minder wasmiddel nodig.
- Sterk geconcentreerd (compact) wasmiddel vereist een bijzonder nauwkeurige dosering.

De volgende symptomen zijn een teken van een te grote dosis wasmiddel:















- zware schuimvorming
- slecht was- en spoelresultaat

De volgende symptomen zijn een teken van een te lage dosis wasmiddel:

- wasgoed wordt grijs
- kalkaanslag op de trommel, het verwarmingselement en/of het wasgoed

Programma's

Programma's zijn beschikbaar naargelang het soort wasgoed.

Programma's		
	Synthetisch	Wassen van synthetische artikelen, zoals overhemden, jassen, gemengde stoffen. Tijdens het wassen van breiwerk moet de hoeveelheid wasmiddel worden verminderd vanwege de losse draadconstructie en het gemakkelijk vormen van bellen.
	Koud wassen	Koud water om kleren te wassen.
    	Katoen	Slijtvast textiel, hittebestendig textiel van katoen of linnen.
	ECO 40-60	Geschikt voor normaal vervuild katoenen wasgoed dat wasbaar is op 40 °C of 60 °C, samen in dezelfde cyclus.
	Katoen Intensief	Om het waseffect te vergroten, wordt de wastijd verlengd.
	Trommel reinigen	Het past een sterilisatie op een hoge temperatuur van 90 °C toe om de kleding op een milieuvriendelijkere manier te wassen. Wanneer dit programma wordt uitgevoerd, kunnen er geen kledingstukken of ander wasgoed worden toegevoegd. Wanneer de juiste hoeveelheid chloorbleekmiddel wordt toegevoegd, zal de trommel beter gereinigd worden. De klant kan dit programma regelmatig gebruiken wanneer nodig.
	Stoomwassen	De stoom kan diep in de vezel doordringen, waardoor bacteriën en ziektekiemen effectief worden verwijderd, geurtjes worden voorkomen en uw gezondheid wordt beschermd.
	Alleen centrifuge	Centrifugeert en laat het water weglopen.
	Spoelen en centrifugeren	Spoelt en centrifugeert het wasgoed en laat het water weglopen.
	Delicaat	Voor delicaat, wasbaar textiel, bijv. van zijde, satijn, synthetische vezels of gemengde stoffen.
	Eindigt in	De functie kan worden ingesteld met dit programma, de totale tijd inclusief wastijd en vertragingstijd is 3u, 6u of 9u.

B

Gebruik van het toestel



Snel wassen

Het is geschikt voor het snel wassen van weinig en niet erg vuile kleding. De wastijd is 15', 30' of 45'.

**Opmerking:**

- Raadpleeg uw product om de programma's te selecteren.

Programma	Lading (kg)	Weergavetijd
	5,0	5,0
Synthetisch	2,5	2:20
Synthetisch 40 °C	2,5	2:20
Koud wassen	5,0	1:00
Koud wassen op 20°C	5,0	1:01
Katoen 30°C	5,0	2:40
Katoen 40°C	5,0	2:40
Katoen 60°C	5,0	2:45
Katoen 90°C	5,0	2:50
ECO 40-60	5,0	3:08
Katoen Intensief 40°C	5,0	3:48
Katoen Intensief 60°C	5,0	3:53
Trommel reinigen	--	1:18
Stoomwassen	5,0	0:12
Alleen centrifuge	2,5	1:27
Spoelen+Centrifuge	5,0	0:20
Delicaat 30°C	2,0	0:50
Delicaat	2,0	0:48
Eindigt over 9u	5,0	0:59
Eindigt over 6u	5,0	0:59
Eindigt over 3u	5,0	0:59
Snel wassen 45'	2,0	0:45
Snel wassen 30'	2,0	0:30
Snel wassen 15'	2,0	0:15

**Opmerking:**

- De parameters in deze tabel zijn alleen bedoeld als referentie voor de gebruiker. De werkelijke parameters kunnen verschillen met de parameters die in de bovenstaande tabel zijn vermeld.

WF 510 D W566C							
Cyclus	Nominale capaciteit in kg	Temperatuur instellen	Cyclustuur in u:min	Energieverbruik in kWh/cyclus	Waterverbruik in L/cyclus	Hoogste was-temperatuur °C ⁽¹⁾	Restvocht in %/ Draaisnelheid ⁽²⁾
Synthetisch	2,5	Koud	2:20	0,327	50	Koud	65%/1 000
Koud wassen op 20°C	2,5	20	1:01	0,201	34	20	65%/1 000
Katoen 60°C	5,0	60	2:45	1,175	51	60	70%/1 000
ECO 40-60 ⁽³⁾	5,0	–	3:08	0,769	46,0	37	71,9 %/1 000
	2,5	–	2:30	0,485	37,0	31	71,9 %/1 000
	1,5	–	2:30	0,368	34,0	28	71,9 %/1 000
Katoen Intensief 40°C	5,0	40	3:48	0,994	51	40	65 %/1 000
Snel wassen 15'	2,0	Koud	0:15	0,035	31	Koud	75%/800

- De bovenstaande gegevens dienen alleen ter referentie en de gegevens kunnen wijzigen als gevolg van verschillende werkelijke gebruiksomstandigheden.
 - De vermelde waarden voor andere programma's dan het programma ECO 40-60 zijn louter indicatief.
 - Koud wassen 20 °C kan licht vervuild katoenen wasgoed schoonmaken bij een nominale temperatuur van 20 °C, wat voldoet aan de verordening (EU) 2019/2023.
 - Voldoet aan EN 60456:2016+A11:2020 met (EU) 2019/2014, (EU) 2019/2023, (EU) 2021/340, (EU) 2021/341.
- De energie-efficiëntieklasse van de EU is: S

Energie-testprogramma: ECO 40-60. Andere als het standaard programma.

Halve belasting voor machine van 5,0 kg: 2,5 kg.

Kwartbelasting voor machine van 5,0 kg: 1,5 kg.

- ⁽¹⁾ De hoogste temperatuur bereikt door het wasgoed in de wascyclus gedurende minimaal 5 minuten.
- ⁽²⁾ Restvocht na de wasbeurt in procentuele watergehalte en centrifugesnelheid waarbij dit werd bereikt.
- ⁽³⁾ Het programma ECO 40-60 is in staat om normaal vervuild katoenen wasgoed dat wasbaar is verklaard op 40°C of 60°C, samen in dezelfde cyclus te wassen. Dit programma wordt gebruikt om de naleving van de verordening (EU) 2019/2023 te beoordelen.

De meest efficiënte programma's in termen van energieverbruik zijn over het algemeen de programma's die goed presteren bij lagere temperaturen en een langere duur.

Door de huishoudelijke wasmachine te vullen tot de capaciteit die is aangegeven voor de respectievelijke programma's, bespaart u op energie en water.

Het lawaai en het resterend vochtgehalte worden beïnvloed door de centrifugesnelheid: hoe hoger de centrifugesnelheid in de centrifugefase, hoe meer lawaai en hoe lager het resterend vochtgehalte.





















Voorzichtig!

- Als er een stroomonderbreking is terwijl de machine in werking is, dan wordt geselecteerde programma in een speciaal geheugen opgeslagen. De machine gaat door met het programma zodra de stroomvoorziening is hersteld.

Optie

	Cyclus	Standaard temp. (°C)	Standaard centrifugesnelheid (tpm)	Extra functies
	Synthetisch	Koud	1 000	Voorwas, Extra spoelen, Niet centrifugeren
	Synthetisch 40°C	40	1 000	Voorwas, Extra spoelen, Niet centrifugeren
	Koud wassen	Koud	1 000	Voorwas, Extra spoelen, Niet centrifugeren
	Koud wassen op 20°C	20	1 000	Voorwas, Extra spoelen, Niet centrifugeren
	Katoen 30°C	30	1 000	Voorwas, Extra spoelen, Niet centrifugeren

 40°C	Katoen 40°C	40	1 000	Voorwas, Extra spoelen, Niet centrifugeren
 60°C	Katoen 60°C	60	1 000	Voorwas, Extra spoelen, Niet centrifugeren
 90°C	Katoen 90°C	90	1 000	Voorwas, Extra spoelen, Niet centrifugeren
 ECO 40-60	ECO 40-60	--	1 000	
 40°C	Katoen Intensief 40°C	40	1 000	Geen centrifuge
 60°C	Katoen Intensief 60°C	60	1 000	Geen centrifuge
	Trommel reinigen	90	--	
	Stoomwassen	40	1 000	Extra spoelen, niet centrifugeren
	Alleen centrifuge	-	1 000	Geen centrifuge
	Spoelen+Centrifuge	-	1 000	Extra spoelen, niet centrifugeren
 30°C	Delicaat 30°C	30	600	Extra spoelen, niet centrifugeren
	Delicaat	Koud	600	Extra spoelen, niet centrifugeren
 9H  6H  3H	Eindigt over 3u/6u/9u	40	1 000	
 45'	Snel wassen 45'	40	800	Geen centrifuge
 30'	Snel wassen 30'	30	800	Geen centrifuge
 15'	Snel wassen 15'	Koud	800	Geen centrifuge



Opmerking:

- Voor de maximale centrifugesnelheid, programmatijd en andere details van het ECO 40-60-programma verwijzen wij u naar de inhoud op de Productfiche-pagina.
- De tabel toont u welke cyclus welke instelmogelijkheden biedt. Als een aanpassing voor een cyclus niet mogelijk is.

**Voorwas**

De voorwasfunctie kan een extra wasbeurt krijgen voor de hoofdwas, het is geschikt voor het wassen van het stof dat naar het oppervlak van de kleding komt; u moet wasmiddel in de het bakje (I) doen wanneer u deze functie selecteert.

**Extra spoelen**

Het wasgoed wordt na het selecteren van deze functie extra gespeld.

**Geen centrifuge**

Er wordt niet gecentrifugeerd als u deze functie kiest.

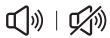
**De zoemer dempen**

Kies het programma



Druk gedurende 3 sec. op de knop [Voorwassen]. De zoemer is gedempt.

Om de zoemerfunctie opnieuw te activeren, druk weer 3 seconden op de knop. De instelling blijft behouden tot de volgende terugzetting.

**Voorzichtig!**

- Na het dempen van de zoemerfunctie zijn de geluiden niet langer actief.

**Kinderslot**

Om verkeerde bediening door kinderen te voorkomen.



Kies het programma



Starten



Druk 3 sec. op [Extra spoelen] en [Geen centrifuge] tot u de zoemer hoort.

**Voorzichtig!**

- Alleen als u de twee knoppen ingedrukt houdt, kunt u het 'Kinderslot' opheffen. Zelfs als u het apparaat uitschakelt, uitzet en het programma beëindigt, vergrendelt het 'Kinderslot' alle knoppen behalve de Aan/uit-knop en de knop 'Kinderslot'.
- Hef het 'Kinderslot' op voordat u het programma selecteert en het wassen start.

**Opmerking:**

Gebruiksteller

1. Haal de stekker 10 seconden uit het stopcontact en steek deze vervolgens weer in het stopcontact
2. Zet het apparaat aan en druk binnen 10 seconden tegelijkertijd en ongeveer 5 seconden onafgebroken op 'Voorwassen' en 'Geen centrifuge' op het bedieningspaneel totdat de zoemer piept.
3. Het aantal keer dat het lampje knippert, vertegenwoordigt een Arabisch cijfer, bijvoorbeeld als de gebruiksteller 3 456 is, knippert 'Voorspoelen' 3 keer; 'Extra spoelen' knippert 4 keer; 'Geen centrifuge' knippert 5 keer; 'Pauze/start' knippert 6 keer.
4. Herhaal stap 1 opnieuw en de normale werking wordt hervat.

Reiniging en onderhoud



Waarschuwing!

- Haal altijd de stekker uit het stopcontact en draai de waterkraan dicht voordat u het apparaat reinigt en onderhoudt.

De buitenkant schoonmaken

Een juist onderhoud van de wasmachine kan de levensduur verlengen. De buitenkant kan indien nodig worden gereinigd met een verdund, niet-schurend en neutraal reinigingsmiddel. Als er water overloopt, gebruik dan een doek om het onmiddellijk weg te vegen.

Gebruik nooit scherpe voorwerpen om het apparaat schoon te maken.

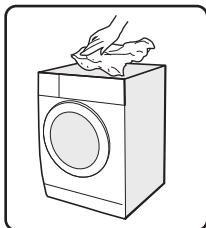

Voorzichtig!

- Gebruik nooit een schurend of bijtend middel, mierenzuur, een verdund oplosmiddel of soortgelijk middel, zoals alcohol of een chemisch product.

De trommel schoonmaken

Roestvlekken die door metalen voorwerpen in de trommel zijn achtergebleven, moeten onmiddellijk worden verwijderd met een chloorvrij reinigingsmiddel. Gebruik nooit staalwol om de trommel schoon te maken!

**Opmerking:**

- Houd tijdens het reinigen van de trommel het wasgoed uit de buurt van de machine.

De deurafdichting en het glas schoonmaken

Veeg het glas en de afdichting na elke wasbeurt schoon om pluis en vlekken te verwijderen. Als er zich pluis ophoopt, kan dit tot lekkage leiden.

Verwijder na elke wasbeurt achterblijvende munten, knopen en andere voorwerpen uit de afdichting.

Reinig de deurafdichting en het glas elke maand om een normale werking van het apparaat te garanderen.

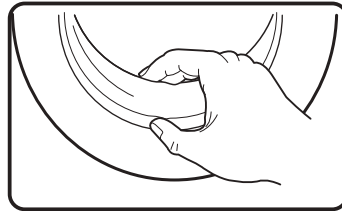
**De inlaatfilter schoonmaken****Opmerking:**

- Een afnemende waterstroom is een teken dat de filter schoongemaakt moet worden.

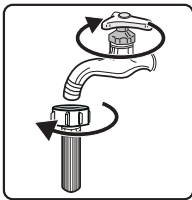

①

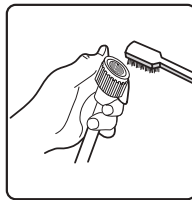

②

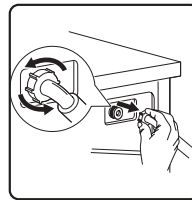

③

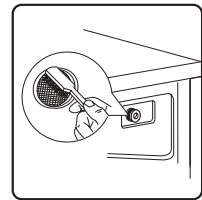

④

1. Draai de kraan dicht en verwijder de watertoevoerslang.
2. Maak de filter schoon met een borstel.
3. Draai de watertoevoerslang los aan de achterkant van de machine. Trek de filter eruit met een platte bektang.

4. Gebruik een borstel om de filter schoon te maken.
5. Plaats de filter terug op de waterinlaat en maak de watertoevoerslang weer vast.
6. Reinig de inlaatfilter elke 3 maanden om een normale werking van het apparaat te garanderen.

De wasmiddellade schoonmaken

1. Duw de ontgrendeling [] op het wasverzachterklepje omlaag en trek de wasmiddellade uit de uitsparing. Reinig de binnenkant van de uitsparing met een borstel.
2. Til het wasverzachterklepje van de wasmiddellade op en was beide onderdelen in water.
3. Plaats het wasverzachterklepje terug en duw de lade terug in de uitsparing.

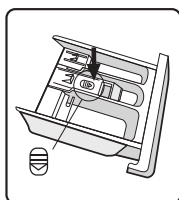

①

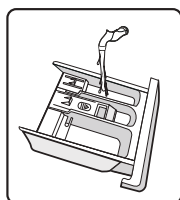

②

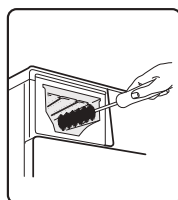

③

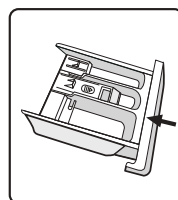

④

1. Druk op de ontgrendeling en verwijder de wasmiddellade.
2. Reinig de wasmiddellade en het wasverzachterklepje onder water.
3. Reinig de uitsparing met een zachte borstel.
4. Plaats de wasmiddellade terug.



Opmerking:

- Gebruik geen schurend of bijtend middel om de plastic onderdelen schoon te maken.
- Reinig de wasmiddellade elke 3 maanden om een normale werking van het apparaat te garanderen

De filter van de afvoerpomp schoonmaken



Waarschuwing!

- Zorg ervoor dat de machine de wascyclus heeft beëindigd en leeg is. Schakel de machine uit en haal de stekker uit het stopcontact voordat u de filter van de afvoerpomp reinigt.
- Wees voorzichtig met heet water. Wacht totdat het water is afgekoeld. Gevaar voor brandwonden!
- Maak de filter regelmatig om de 3 maanden schoon om een normale werking van het apparaat te garanderen.

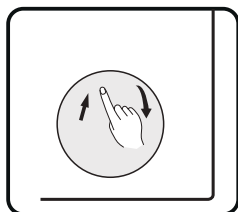

①

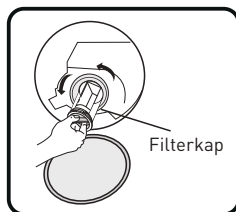

②

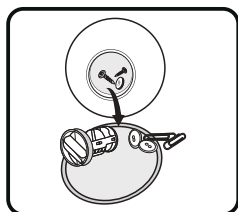

③

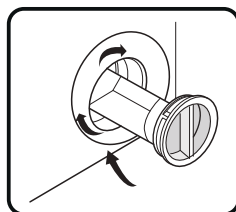

④

1. Open de onderste afdekkap.
2. Open de filter door deze tegen de klok in te draaien.
3. Verwijder vreemde stoffen.
4. Sluit de onderste afdekkap.



Voorzichtig!

- Als het apparaat in gebruik is en afhankelijk van het gekozen programma kan er heet water in de pomp zitten. Verwijder nooit het pompdeksel tijdens een wasprogramma. Wacht altijd totdat het apparaat klaar is met het programma en leeg is. Zorg er bij het terugplaatsen van het deksel voor dat het stevig vastzit.

Probleemoplossing

Wanneer er een probleem is met het apparaat, controleer of u het zelf kunt oplossen aan de hand van de onderstaande tabel.

Beschrijving	Mogelijke oorzaak	Oplossing
Apparaat start niet	<ul style="list-style-type: none"> • Deur is niet goed dicht. • Kleding zit vast. 	<ul style="list-style-type: none"> • Sluit de deur goed en start opnieuw op. • Controleer het wasgoed.
Deur kan niet worden geopend	<ul style="list-style-type: none"> • De veiligheidsbescherming is geactiveerd. 	<ul style="list-style-type: none"> • Trek de stekker uit het stopcontact en start opnieuw.
Waterlekkage	<ul style="list-style-type: none"> • Verbindingen zijn niet stevig vastgemaakt. 	<ul style="list-style-type: none"> • Controleer de watertoevoering en maak deze vast. • Controleer en reinig de afvoerslang.
Wasmiddelresten in de wasmiddellade.	<ul style="list-style-type: none"> • Wasmiddel is vochtig en/of klonterig. 	<ul style="list-style-type: none"> • Reinig en veeg de wasmiddellade droog.
Controlelampje of display werkt niet	<ul style="list-style-type: none"> • Printplaat of kabelboom heeft verbingsproblemen. 	<ul style="list-style-type: none"> • Schakel de stroom uit en controleer of de stekker goed is aangesloten.
Abnormaal geluid	<ul style="list-style-type: none"> • Zitten de bevestigingsbouten nog steeds op hun plaats. • De vloer is niet stevig of vlak. 	<ul style="list-style-type: none"> • Controleer of de bevestigingsbouten zijn verwijderd. • Zorg ervoor dat het apparaat op een stevige en vlakke vloer staat.

Beschrijving	Mogelijke oorzaak	Oplossing
Foutcodes		
 Pauze/start Geen centrifuge Extra spoelen Voorwas	<ul style="list-style-type: none"> • Deur is niet goed dicht. 	<ul style="list-style-type: none"> • Start opnieuw op nadat de deur is gesloten. • Controleer of er geen kleding vastzit.
Uit Uit Knippert	Uit Uit Uit	<ul style="list-style-type: none"> • Waterinjectieprobleem tijdens het wassen.
Uit Uit Knippert	Uit Uit Knippert	<ul style="list-style-type: none"> • Het afvoeren van het water duurt erg lang.
Uit Uit Knippert	Uit Uit Knippert	<ul style="list-style-type: none"> • Er loopt water over.
Uit Uit Knippert	Uit Uit Knippert	<ul style="list-style-type: none"> • Overige
		<ul style="list-style-type: none"> • Controleer de afvoerslang op mogelijke verstopping. • Schakel de wasmachine opnieuw in. • Probeer het eerst opnieuw, bel de servicelijn als er nog steeds problemen zijn.

Transport

BELANGRIJKE STAPPEN BIJ HET VERPLAATSEN VAN HET APPARAAT

- Haal de stekker uit het stopcontact en draai de watertoevoerkraan dicht.
- Controleer of de deur en de wasmiddellade goed gesloten zijn.
- Verwijder de watertoevoleiding en de afvoerslang van de installaties in uw woning.
- Laat het water volledig uit het apparaat lopen (zie 'De filter van de afvoerpomp schoonmaken')
- Belangrijk: Breng de 4 transportbouten opnieuw aan in de achterkant van het apparaat.
- Dit apparaat is zwaar. Wees voorzichtig tijdens het transport. Houd nooit een uitstekend deel van de machine vast tijdens het optillen. De deur van de machine kan niet als handgreep worden gebruikt.

Productfiche

Naam of handelsmerk van de leverancier^{(a),(c)}:

Adres van leverancier^{(a),(c)}:

Typeaanduiding^(a) : WF 510 D W566C

Algemene productparameters:

Parameter	Waarde		Parameter	Waarde	
Nominiaal vermogen ^(b) (kg)	5,0		Afmetingen in cm ^{(a),(c)}	Lengte	85
				Breedte	60
				Diepte	40
Energie-efficiëntie-index (EEI _w) ^(b)	79,9		Energie-efficiëntieklasse ^(b)	D ^(d)	
Wasefficiëntie-index ^(b)	1,031		Spoeefficiëntie (g/kg) ^(b)	5,0	
Energieverbruik in kWh per cyclus, gebaseerd op het eco 40-60-programma. Het werkelijk energieverbruik hangt af van hoe het apparaat wordt gebruikt.	0,602		Waterverbruik in liter per cyclus, gebaseerd op het eco 40-60-programma. Het werkelijk waterverbruik hangt af van hoe het apparaat wordt gebruikt en van de hardheid van het water.	41	
Maximale temperatuur binnenin het behandelde textiel ^(b) (°C)	Nominale capaciteit	37	Gewogen resterend vochtgehalte ^(b) (%)	71,9	
	Half	31			
	Kwart	28			
Draaisnelheid ^(b) (tr/min)	Nominale capaciteit	1 000	Centrifuge-efficiëntieklasse ^(b)	D ^(d)	
	Half	1 000			
	Kwart	1 000			

Productfiche

Programmaduur ^(b) (u:min)	Nominale capaciteit	3:08	Type	vrijstaand
	Half	2:30		
	Kwart	2:30		
Geluidsemissie via de lucht in de centrifugefase ^(b) (dB(A) re 1 pW)	79		Geluidsemissie via de lucht-klasse (centrifugefase)	C ^(d)
Uit-modus (W) (indien van toepassing)	0,50		Stand-bystand (W) (indien van toepassing)	1,00
Uitgestelde start (W) (indien van toepassing)	4,00		Netwerkgebonden stand-by (W) (indien van toepassing)	NVT
Minimale duur van de door de leverancier geboden garantie^{(a),(c)}:				
Dit product is ontworpen om zilverionen tijdens de wascyclus vrij te geven			NEE	

Aanvullende informatie:

Weblink naar de website van de leverancier, waar de informatie in punt 9 van Bijlage II bij Verordening (EU) 2019/2023 van de Commissie ⁽¹⁾ te vinden is:

^(a) dit item wordt niet relevant geacht voor de toepassing van artikel 2(6) van Verordening (EU) 2017/1369,

^(b) voor het eco 40-60-programma.

^(c) wijzigingen in deze items worden niet als relevant beschouwd voor de toepassing van artikel 4, lid 4, van Verordening (EU) 2017/1369.

^(d) als de productendatabank automatisch de definitieve inhoud van deze cel genereert, zal de leverancier deze gegevens niet invoeren.



¡Muchas!

Muchas gracias por haber elegido nuestro producto HIGHONE. Seleccionados, testados y recomendados por ELECTRO DEPOT, los productos de la marca HIGHONE le aseguran una utilización sencilla, un rendimiento fiable y una calidad incuestionable.

Con este dispositivo puede estar seguro de que siempre quedará satisfecho al utilizarlo. Le damos la bienvenida a ELECTRO DEPOT.

Visite nuestra página web: www.electrodepot.es



ELECTRO DEPOT

90

ES

A

**Descripción del
aparato**

Partes
Especificaciones

B

**Utilización del
aparato**

Instalación
Funcionamiento

C

**Limpieza y
mantenimiento**

Limpieza y mantenimiento
Solución de problemas
Transporte

Ficha del producto

Partes

A Puerta

B Dispensador de detergente

C Panel de control

D Manguera de desagüe

E Cable de alimentación

F Tapa de mantenimiento

G 4 tapas

H 1 manguera de suministro de agua fría

I Esponja acústica (opcional)



Nota:

- La imagen del producto tiene fines meramente ilustrativos, consulte el producto real como referencia.

Especificaciones

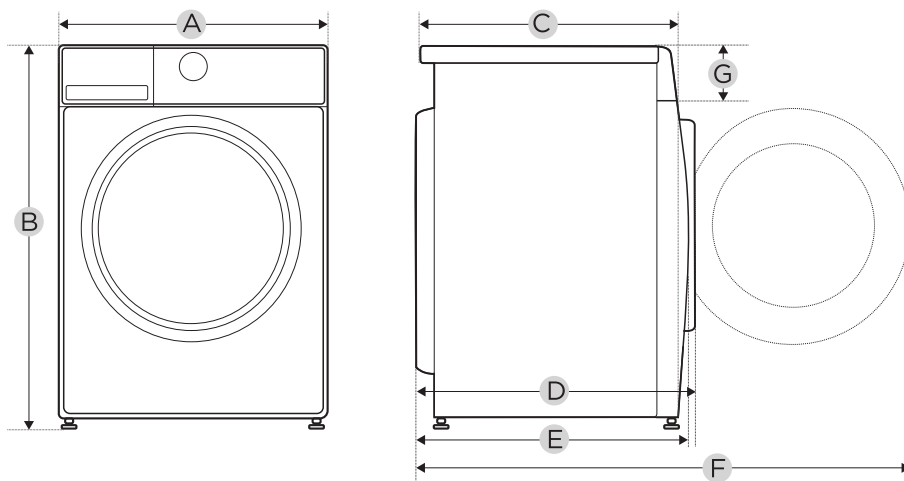

Modelo: **981282 - WF 510 D W566C**

Fuente de alimentación: 220-240 V~, 50 Hz

Corriente máx.: 10A

Presión de agua estándar: 0,05 MPa ~ 1 MPa

Capacidad de lavado: 5,0 kg

Dimensiones

A: 595 mm

B: 850 mm

C: 435 mm

Peso: 52 kg

Potencia nominal: 2 000 W

Dimensión de referencia

D: 440 mm

E: 400 mm

F: 900 mm

G: 156 mm

Instalación

Herramientas necesarias si la instalación la realiza usted mismo (no incluidas)

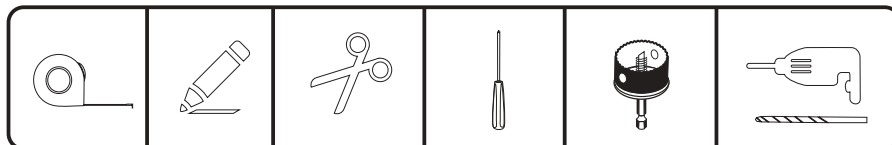

Zona de instalación

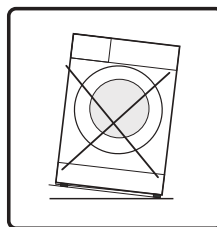
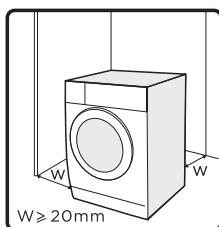

¡Advertencia!

- ¡La estabilidad es importante para evitar que el producto se desplace!
- Asegúrese de que la lavadora esté en posición vertical, nivelada y estable.
- Asegúrese de que el producto no esté colocado sobre el cable de alimentación.
- Asegúrese de mantener las distancias mínimas de las paredes como se muestra en la imagen.

Antes de instalar la lavadora, se seleccionará la ubicación caracterizada como sigue:

- Superficie rígida, seca y nivelada.
- Evite la luz solar directa.
- Ventilación suficiente.
- Temperatura ambiente superior a 5 °C.
- Manténgalo alejado de las fuentes de calor, como el carbón o los aparatos de combustión de gas.

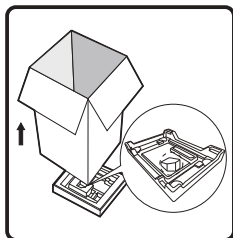
Desembalar la lavadora**¡Advertencia!**

- El material de embalaje (por ejemplo: películas, espuma de poliestireno) puede ser peligroso para los niños.
- ¡Existe riesgo de asfixia! Mantenga todos los materiales de embalaje alejados de los niños.

1. Retire la caja de cartón y el embalaje de espuma de poliestireno.
2. Levante la lavadora y retire el embalaje de la base.
3. Retire la cinta que sujeta el cable de alimentación y el tubo de desagüe.
4. Saque la manguera de entrada del tambor.

Quite los pernos de transporte**¡Advertencia!**

- Deberá quitar los pernos de transporte de la parte posterior antes de usar el producto.

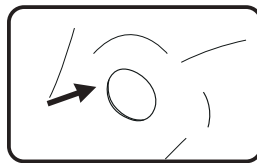
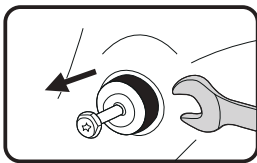
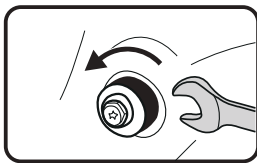

1. Afloje los 4 pernos de transporte con una llave.
2. Retire los pernos, incluyendo las piezas de goma y guárdelos para futuros usos.
3. Cierre los agujeros con las tapas.

Nivelar la lavadora**¡Advertencia!**

- Las tuercas de bloqueo de las cuatro patas deberán atornillarse firmemente contra la carcasa.

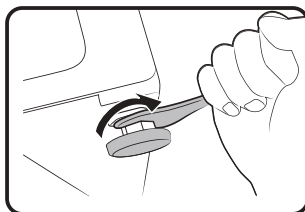

1. Afloje la tuerca de bloqueo.
2. Gire la pata hasta que llegue al suelo.
3. Ajuste las patas y bloquee las tuercas con una llave. Asegúrese de que la lavadora está nivelada utilizando un nivel de burbuja.

Conecte la manguera de suministro de agua



¡Advertencia!

Para evitar fugas o daños por agua, siga las instrucciones incluidas en este capítulo.

- No retuerza, aplaste ni modifique la manguera de entrada de agua.

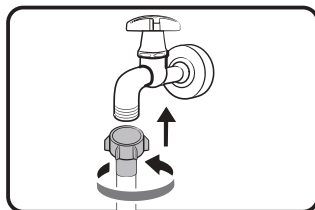
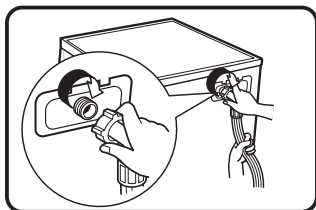

Conecte la manguera de suministro de agua a la válvula de entrada de agua y un grifo de agua fría tal y como se indica.



Nota:

- Conéctela manualmente, no use herramientas. Compruebe que las conexiones estén apretadas.

Tubo de desagüe



¡Advertencia!

- No retuerza ni alargue el tubo de desagüe.
- Coloque el tubo de desagüe correctamente; de lo contrario, se podrían producir daños por fugas de agua.
- No está permitido quitar el conector del tubo de desagüe.

Hay dos maneras de colocar el extremo del tubo de desagüe:

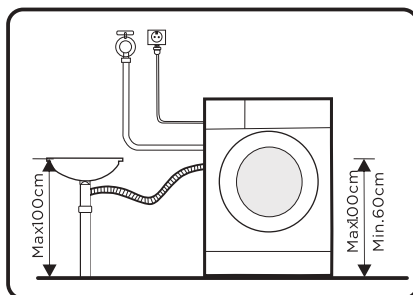
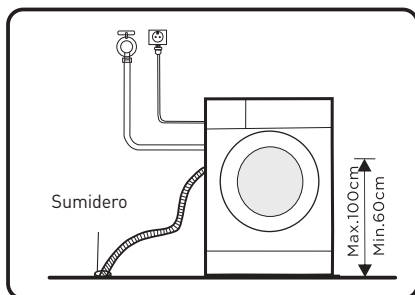

1. Introdúzcalo en el sumidero.
2. Conéctelo a la tubería de desagüe.

Espuma acústica



Nota:

- Asegúrese de montar las esponjas acústicas, que pueden reducir eficazmente el ruido causado por la lavadora durante su funcionamiento, para proporcionarle un ambiente más tranquilo y silencioso.

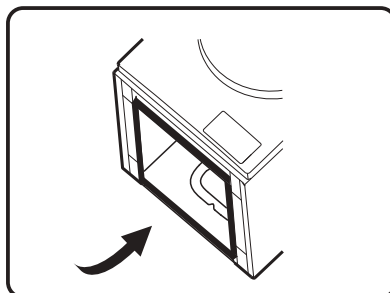
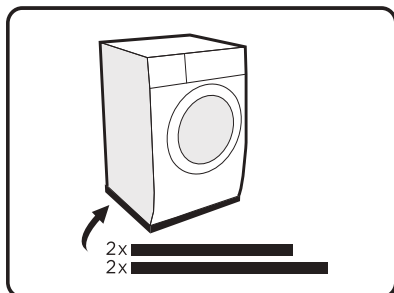

1. Tumbela lavadora en el suelo, utilizando algún material blando como espuma o ropa entre la lavadora y el suelo para protegerla.
2. Pegue las 2 esponjas más largas en los bordes inferiores más largos de la lavadora; y las 2 esponjas más cortas, en los bordes inferiores más cortos.

Funcionamiento

Inicio rápido



¡Precaución!

- Antes de lavar, asegúrese de que la lavadora esté instalada correctamente.
- Su aparato fue revisado minuciosamente antes de salir de la fábrica. Para eliminar el agua residual y neutralizar los posibles olores, se recomienda limpiar el aparato antes del primer uso. Por esta razón, se recomienda limpiar el tambor interior activando el programa «Limpieza del tambor» u otro programa con la temperatura opcional de 90 °C. Tenga cuidado de no introducir ropa ni detergente en la lavadora.

• Antes del lavado



1

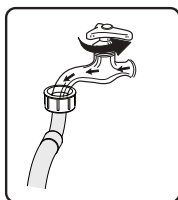

2

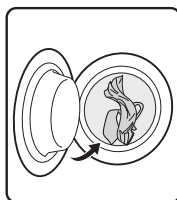

3

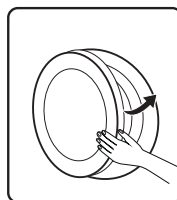

4

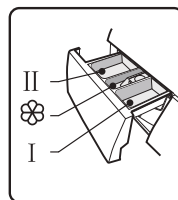

5

1. Enchufar
2. Abrir el grifo
3. Cargar
4. Cerrar la puerta
5. Añadir el detergente



Nota:

- Es necesario añadir detergente en el compartimento I si se selecciona la función de prelavado.

- **Lavado**

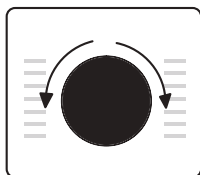

①

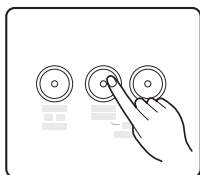

②

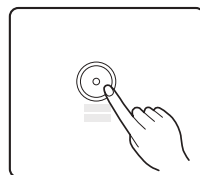

③

1. Seleccionar el programa
2. Seleccionar la función o mantener los ajustes predeterminados
3. Pulsar Inicio/Pausa para iniciar el programa

**Nota:**

1. Si está seleccionado el ajuste predeterminado, se puede omitir el paso 2.
2. El gráfico de líneas de botones de función se indica solamente como referencia, consulte el producto real como estándar.

- **Después del lavado**

Tono de aviso.

Antes de cada lavado

- La temperatura ambiente de la lavadora deberá ser de 5 °C a 40 °C. Si se usa a menos de 0 °C, la válvula de entrada y el sistema de desagüe pueden sufrir daños. Si la lavadora está colocada bajo condiciones de congelación, deberá llevarla a un lugar donde haya una temperatura ambiente normal para garantizar que la manguera de suministro de agua y el tubo de desagüe puedan descongelarse antes de su uso.
- Consulte las etiquetas de cuidados de sus prendas y las instrucciones de uso del detergente antes de lavarlas. Utilice detergente no espumante o menos espumante adecuado para lavar a máquina correctamente.

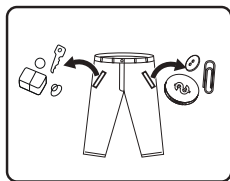

①

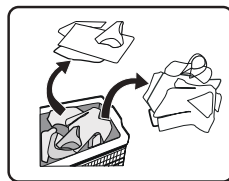

②

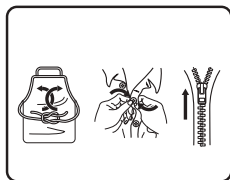

③

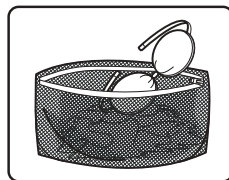



④

1. Saque todos los objetos de los bolsillos
2. Separe las prendas por color y tipo de tela
3. Ate los cordones y cinturones largos, cierre las cremalleras y los botones
4. Meta las prendas pequeñas en una bolsa de colada

**¡Advertencia!**

- No lave prendas que hayan sido limpiadas, lavadas, impregnadas o remojadas en sustancias combustibles o explosivas como cera, aceite, pintura, gasolina, alcohol, queroseno y otros materiales inflamables.
- Lavar una sola prenda puede crear fácilmente una gran excentricidad. Por lo tanto, se recomienda añadir una o dos prendas más para lavarlas juntas para que el centrifugado se pueda hacer sin problemas.
- No lave, centrifugue ni seque esterillas, ropa o asientos impermeables.

Dispensador de detergente

- I Prelavado
- II Lavado principal
-  Suavizante
-  Botón de liberación para sacar el dispensador

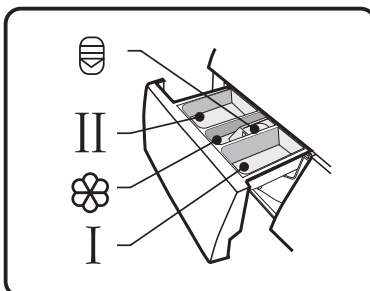



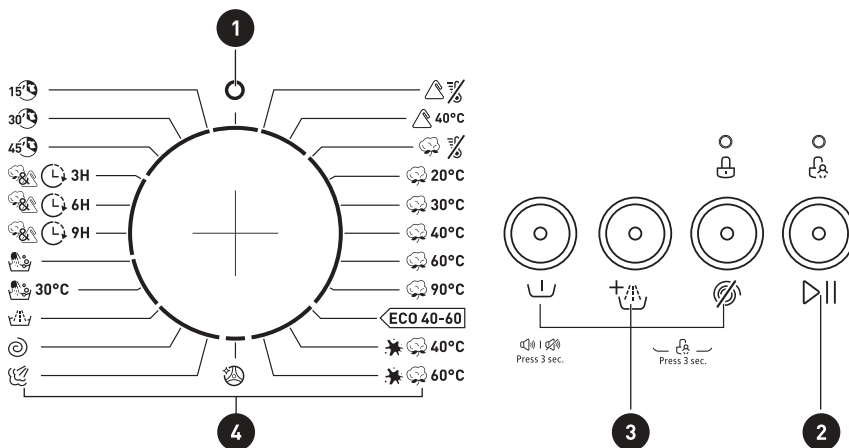

¡Precaución!

- Solo es necesario añadir detergente en el "compartimento I" después de seleccionar la función de prelavado.
- No eche perlas de detergente en el dispensador de detergente.

Panel de control



1 Apagado	Encienda y apague el aparato.
2 Inicio/Pausa	Inicie o pause su programa.
3 Opción	Permite seleccionar funciones adicionales y se iluminará cuando se seleccione.
4 Programas	Disponibles según el tipo de prendas.

Programa	I	II/△	
 Sintético	<input type="radio"/>	<input checked="" type="radio"/>	<input type="radio"/>
 Sintético 40 °C	<input type="radio"/>	<input checked="" type="radio"/>	<input type="radio"/>
 Lavado en frío	<input type="radio"/>	<input checked="" type="radio"/>	<input type="radio"/>
 Lavado en frío 20 °C	<input type="radio"/>	<input checked="" type="radio"/>	<input type="radio"/>
 Algodón 30 °C	<input type="radio"/>	<input checked="" type="radio"/>	<input type="radio"/>
 Algodón 40 °C	<input type="radio"/>	<input checked="" type="radio"/>	<input type="radio"/>
 Algodón 60 °C	<input type="radio"/>	<input checked="" type="radio"/>	<input type="radio"/>
 Algodón 90 °C	<input type="radio"/>	<input checked="" type="radio"/>	<input type="radio"/>
 ECO 40-60		<input checked="" type="radio"/>	<input type="radio"/>
 Intensivo de algodón 40 °C		<input checked="" type="radio"/>	<input type="radio"/>
 Intensivo de algodón 60 °C		<input checked="" type="radio"/>	<input type="radio"/>
 Limpieza del tambor			<input type="radio"/>
 Lavado con vapor		<input checked="" type="radio"/>	<input type="radio"/>
 Solo centrifugado			
 Aclarado + Centrifugado			<input type="radio"/>
 Ropa delicada 30 °C		<input checked="" type="radio"/>	<input type="radio"/>
 Ropa delicada		<input checked="" type="radio"/>	<input type="radio"/>
 Termina en 9 horas		<input checked="" type="radio"/>	<input type="radio"/>
 Termina en 6 horas		<input checked="" type="radio"/>	<input type="radio"/>
 Termina en 3 horas		<input checked="" type="radio"/>	<input type="radio"/>
 Lavado rápido 45'		<input checked="" type="radio"/>	<input type="radio"/>
 Lavado rápido 30'		<input checked="" type="radio"/>	<input type="radio"/>
 Lavado rápido 15'		<input checked="" type="radio"/>	<input type="radio"/>

● Significa «obligatorio» ○ Significa «opcional»

Recomendación de detergente

Detergente de lavado recomendado	Tipo de prenda y de tela	Ciclos de lavado	Temperatura de lavado °C
Detergente fuerte con agentes blanqueadores y blanqueadores ópticos	Prendas blancas de lino o algodón a prueba de ebullición	Algodón, ECO 40-60	30/40/60/90
Detergente para color sin agente blanqueador ni blanqueadores ópticos	Prendas de color de algodón o lino	Algodón, ECO 40-60, Lavado en frío	Fría/20/30/40/60/90
Detergente para color o suave sin blanqueadores ópticos	Ropa de color de fibras de fácil cuidado o materiales sintéticos	Lavado en frío, Sintético	Fría/20/40
Detergente de lavado suave	Telas delicadas, seda, viscosa	Sintético	Frío /40

**Nota:**

- El detergente o aditivo aglomerante o viscoso se puede diluir en un poco de agua antes de echarlo en el dispensador de detergente, para evitar que su entrada se bloquee y provoque un desbordamiento del agua.
- Elija el tipo de detergente adecuado para conseguir el máximo rendimiento de lavado y un mínimo consumo de agua y energía.
- Para lograr el mejor resultado de limpieza es importante una dosificación adecuada del detergente.
- Use una cantidad reducida de detergente si el tambor no está completamente lleno.
- Ajuste siempre la cantidad de detergente a la dureza del agua; si el agua del grifo es blanda, use menos detergente.
- Dosifique según lo sucia que esté la ropa, las prendas menos sucias requieren menos detergente.
- Los detergentes muy concentrados (detergentes compactos) requieren una dosificación especialmente precisa.

Los siguientes síntomas son un signo de sobredosis de detergente:





















- Formación de espuma densa
- Malos resultados del lavado y aclarado

Los siguientes síntomas son un signo de dosificación insuficiente de detergente:

- Las prendas se vuelven grises
- Se acumulan depósitos de cal en el tambor, el elemento calefactor y/o la ropa

Programas

Programas disponibles según el tipo de prendas.

Programas		
	Sintético	Lave prendas sintéticas, por ejemplo: camisas, abrigos o mezclas. Cuando se laven los tejidos de punto, la cantidad de detergente se reducirá debido a su fabricación de hilo suelto y a la fácil formación de burbujas.
	Lavado en frío	Agua fría para lavar la ropa.
    	Algodón	Telas muy resistentes o resistentes al calor de algodón o de lino.
	ECO 40-60	Puede lavar juntas en el mismo ciclo las prendas de algodón normalmente sucias que se pueden lavar a 40 °C o 60 °C.
 	Intensivo de algodón	Para aumentar los efectos del lavado, se aumenta el tiempo de lavado.
	Limpieza del tambor	Aplica una esterilización a una alta temperatura de 90 °C para hacer que el lavado de ropa sea más ecológico. Cuando se realiza este procedimiento, no se puede añadir ropa ni otro tipo de lavado. Cuando se coloca la cantidad adecuada de agente blanqueador de cloro, mejora el efecto de limpieza del tambor. Puede utilizar este programa regularmente según sus necesidades.
	Lavado con vapor	El Lavado con vapor puede penetrar profundamente en la fibra, lo que elimina eficazmente bacterias y gérmenes, previniendo los olores y protegiendo la salud.
	Solo centrifugado	Gira y escurre el agua.
	Aclarar y centrifugar	Aclara y luego centrifuga las prendas, y después desagua el agua.
	Ropa delicada	Para tejidos delicados y lavables; como seda, satén, fibras sintéticas o tejidos mixtos.
  	Termina en	La función se puede ajustar con este programa, el tiempo total incluyendo el tiempo de lavado y el tiempo de retardo es de 3 h, 6 h o 9 h.
  	Lavado rápido	Es adecuado para lavar rápidamente poca ropa y no muy sucia. El tiempo de lavado es de 15', 30' o 45'.

B

Utilización del aparato



Nota:

- Consulte su producto para seleccionar los programas.

Programa	Carga (kg)	Tiempo de retardo
	5,0	5,0
Sintético	2,5	2:20
Sintético 40 °C	2,5	2:20
Lavado en frío	5,0	1:00
Lavado en frío 20 °C	5,0	1:01
Algodón 30 °C	5,0	2:40
Algodón 40 °C	5,0	2:40
Algodón 60 °C	5,0	2:45
Algodón 90 °C	5,0	2:50
ECO 40-60	5,0	3:08
Intensivo de algodón 40 °C	5,0	3:48
Intensivo de algodón 60 °C	5,0	3:53
Limpieza del tambor	--	1:18
Lavado con vapor	5,0	0:12
Solo centrifugado	2,5	1:27
Aclarado + Centrifugado	5,0	0:20
Ropa delicada 30 °C	2,0	0:50
Ropa delicada	2,0	0:48
Termina en 9 horas	5,0	0:59
Termina en 6 horas	5,0	0:59
Termina en 3 horas	5,0	0:59
Lavado rápido 45'	2,0	0:45
Lavado rápido 30'	2,0	0:30
Lavado rápido 15'	2,0	0:15

**Nota:**

- Los parámetros de esta tabla se indican únicamente como referencia para el usuario. Los ajustes reales pueden diferir de los de la tabla anterior.

WF 510 D W566C							
Ciclo	Capacidad nominal en kg	Ajuste de la temperatura	Duración del ciclo en h:min	Consumo de energía en kWh/ciclo	Consumo de agua en L/ciclo	Temperatura de lavado más alta °C ⁽¹⁾	Humedad residual en %/ Velocidad de centrifugado ⁽²⁾
Sintético	2,5	Fría	2:20	0,327	50	Fría	65%/1 000
Lavado en frío 20 °C	2,5	20	1:01	0,201	34	20	65%/1 000
Algodón 60 °C	5,0	60	2:45	1,175	51	60	70%/1 000
ECO 40-60 ⁽³⁾	5,0	–	3:08	0,769	46,0	37	71,9%/1 000
	2,5	–	2:30	0,485	37,0	31	71,9%/1 000
	1,5	–	2:30	0,368	34,0	28	71,9%/1 000
Intensivo de algodón 40 °C	5,0	40	3:48	0,994	51	40	65%/1 000
Lavado rápido 15'	2,0	Fría	0:15	0,035	31	Fría	75%/800

- Los datos anteriores se indican solamente como referencia, y los datos pueden cambiar debido a las diferentes condiciones de uso reales.
- Los valores indicados para programas distintos al programa ECO 40-60 son únicamente indicativos.
- El Lavado en frío a 20°C puede lavar prendas de algodón ligeramente sucias, a una temperatura nominal de 20 °C, que cumple con el reglamento (UE) 2019/2023.
- Conforme a EN 60456:2016+A11:2020 con (UE) 2019/2014, (UE) 2019/2023, (UE) 2021/340, (UE) 2021/341.
La clase de eficiencia energética de la UE es: S

Programa de pruebas energéticas: ECO 40-60. Otro por defecto.

Media carga para lavadora de 5,0 kg: 2,5 kg.

Cuarto de carga para lavadora de 5,0 kg: 1,5 kg.

- ⁽¹⁾ La temperatura más alta alcanzada por la ropa en el ciclo de lavado durante al menos 5 minutos.
- ⁽²⁾ La humedad residual después del ciclo de lavado en el porcentaje del contenido de agua y la velocidad de centrifugado a la que llegó.
- ⁽³⁾ El programa ECO 40-60 puede lavar juntas en el mismo ciclo las prendas de algodón normalmente sucias que se pueden lavar a 40 °C o 60 °C. Este programa se utiliza para evaluar el cumplimiento del Reglamento (UE) 2019/2023.

Los programas más eficientes en términos de consumo de energía son generalmente los que funcionan a temperaturas más bajas y con una mayor duración.

La carga de la lavadora doméstica hasta la capacidad indicada para los respectivos programas contribuye al ahorro de energía y agua.





El ruido y la cantidad de humedad restante dependen de la velocidad de centrifugado: cuanto mayor sea la velocidad de centrifugado en la fase de centrifugado, mayor será el ruido y menor la humedad restante.



¡Precaución!

















- Si hay algún corte de alimentación mientras la lavadora está funcionando, una memoria especial guardará el programa seleccionado. La lavadora continuará el programa cuando se restablezca la fuente de alimentación.

Opción

Ciclo	Temperatura predeterminada (°C)	Velocidad de centrifugado predeterminada (rpm)	Funciones adicionales
 Sintético	Fría	1 000	Prelavado, Aclarado extra, Sin centrifugado
 Sintético 40 °C	40	1 000	Prelavado, Aclarado extra, Sin centrifugado
 Lavado en frío	Fría	1 000	Prelavado, Aclarado extra, Sin centrifugado
 Lavado en frío 20 °C	20	1 000	Prelavado, Aclarado extra, Sin centrifugado
 Algodón 30 °C	30	1 000	Prelavado, Aclarado extra, Sin centrifugado

B

Utilización del aparato

 40°C	Algodón 40 °C	40	1 000	Prelavado, Aclarado extra, Sin centrifugado
 60°C	Algodón 60 °C	60	1 000	Prelavado, Aclarado extra, Sin centrifugado
 90°C	Algodón 90 °C	90	1 000	Prelavado, Aclarado extra, Sin centrifugado
 ECO 40-60	ECO 40-60	--	1 000	
 40°C	Intensivo de algodón 40 °C	40	1 000	Sin centrifugado
 60°C	Intensivo de algodón 60 °C	60	1 000	Sin centrifugado
	Limpieza del tambor	90	--	
	Lavado con vapor	40	1 000	Aclarado extra, Sin centrifugado
	Solo centrifugado	-	1 000	Sin centrifugado
	Aclarado + Centrifugado	-	1 000	Aclarado extra, Sin centrifugado
 30°C	Ropa delicada 30 °C	30	600	Aclarado extra, Sin centrifugado
	Ropa delicada	Fría	600	Aclarado extra, Sin centrifugado
	Termina en 3 h/6 h/9 h	40	1 000	
 45'	Lavado rápido 45'	40	800	Sin centrifugado
 30'	Lavado rápido 30'	30	800	Sin centrifugado
 15'	Lavado rápido 15'	Fría	800	Sin centrifugado

**Nota:**

- Para conocer la velocidad máxima de centrifugado, el tiempo del programa y otra información del programa ECO 40-60, consulte el contenido en la página de la Ficha del producto.
- La tabla muestra las opciones de ajuste que ofrece cada ciclo. Si no es posible realizar un ajuste para un ciclo.

**Prelavado**

La función Prelavado permite realizar un lavado adicional antes del lavado principal, es adecuada para lavar el polvo de la superficie de la ropa; deberá introducir detergente en el Compartimento (II) cuando la seleccione.

**Aclarado extra**

Se realizará un aclarado adicional de las prendas una vez que la seleccione.

**Sin centrifugado**

No centrifugará si selecciona esta función.

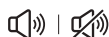
**Silenciar el tono de aviso**

Seleccione el programa

Pulse el botón [Prelavado] durante 3 segundos, el tono de aviso se silenciará.

Para activar la función del tono de aviso, presione el botón de nuevo durante 3 segundos. El ajuste se mantendrá hasta el siguiente reajuste.

**¡Precaución!**

- Después de silenciar la función del tono de aviso, los sonidos ya no se activarán.

**Bloqueo para niños**

Para evitar la manipulación inadecuada por parte de niños.



Seleccione el programa

Inicio

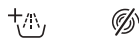

Pulse [Aclarado extra] y [Sin centrifugado] durante 3 segundos hasta que suene el tono de aviso.

**¡Precaución!**

- Solo manteniendo pulsados los dos botones se puede liberar el «Bloqueo para niños»; incluso apagado, apagado y con el programa finalizado, el «Bloqueo para niños» bloqueará todos los botones excepto el botón de encendido y el botón «Bloqueo para niños».
- Libere el «Bloqueo para niños» antes de seleccionar el programa e iniciar el lavado.

**Nota:**

Contador de uso

1. Desenchufe el aparato durante 10 segundos y vuelva a conectarlo.
2. Encienda el aparato y, en 10 segundos, pulse «Prelavado» y «Sin centrifugado» en el panel de control continua y simultáneamente durante unos 5 segundos hasta que suene el tono de aviso.
3. El número de veces que parpadea la luz representa un dígito arábigo; por ejemplo, el número de veces del uso del aparato es 3 456, «Prelavado» parpadea 3 veces, «Aclarado Extra» parpadea 4 veces, «Sin Centrifugado» parpadea 5 veces y «Pausa/Inicio» parpadea 6 veces.
4. Repita el paso 1 de nuevo y podrá reanudar el funcionamiento normal.

Limpieza y mantenimiento



¡Advertencia!

- Desenchufe siempre el aparato y cierre el grifo de agua antes de la limpieza y el mantenimiento.

Limpieza de la carcasa

El mantenimiento adecuado de la lavadora puede alargar su vida útil. La superficie se puede limpiar con detergentes neutros no abrasivos diluidos cuando sea necesario. Si hay algún desbordamiento de agua, use una toalla para limpiarla inmediatamente.

Nunca use objetos afilados para limpiar el aparato.

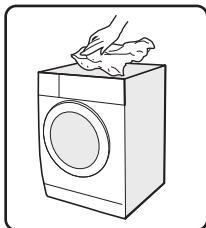

¡Precaución!

- Nunca use agentes abrasivos o cáusticos, ácidos fórmicos o sus disolventes diluidos o sustancias similares, como alcohol o productos químicos.

Limpieza del tambor

Las manchas de óxido que queden dentro del tambor por los objetos metálicos deben eliminarse inmediatamente usando detergentes sin cloro. ¡Nunca use estropajos metálicos para limpiar el tambor!



Nota:

- Mantenga la ropa alejada de la lavadora mientras limpia el tambor.

Limpieza del cristal y la junta de la puerta

Limpie el cristal y la junta después de cada lavado para eliminar pelusas y manchas. Si se acumulan pelusas, pueden producirse fugas.

Quite todas las monedas, botones y otros objetos que hayan podido quedar en la junta después de cada lavado.

Limpie el cristal y la junta de la puerta cada mes para asegurarse de que el aparato funcione con normalidad.

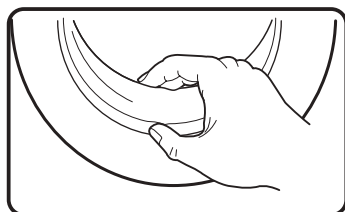

Limpieza del filtro de entrada



Nota:

- La disminución del flujo de agua es una señal de que el filtro debe limpiarse.

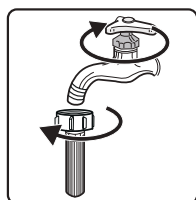

①

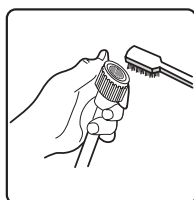

②

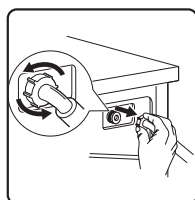

③

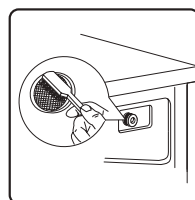

④

1. Cierre el grifo y retire la manguera de suministro de agua del mismo.
2. Limpie el filtro con un cepillo.
3. Desenrosque la manguera de suministro de agua de la parte trasera de la lavadora. Saque el filtro con unos alicates de punta.
4. Utilice un cepillo para limpiar el filtro.
5. Vuelva a colocar el filtro en la entrada de agua y vuelva a conectar la manguera de suministro de agua.

6. Limpie el filtro de entrada cada 3 meses para asegurarse de que el aparato funcione con normalidad.

Limpie el dispensador de detergente

1. Presione hacia abajo el botón de liberación [] de la tapa del suavizante y saque de la cavidad el cajón del dispensador. Limpie el interior de la cavidad con un cepillo.
2. Saque la tapa del suavizante del cajón del dispensador y lave las dos piezas con agua.
3. Vuelva a colocar la tapa del suavizante y empuje el cajón dentro de la cavidad.

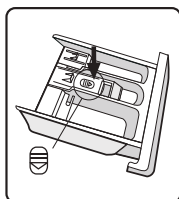

①

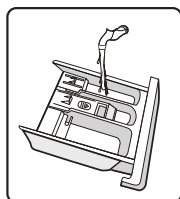

②

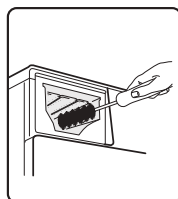

③

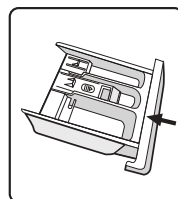

④

1. Pulse el desbloqueo y saque el dispensador.
2. Limpie el cajón del dispensador y la tapa del suavizante bajo el grifo.
3. Limpie la cavidad con un cepillo suave.
4. Introduzca el cajón del dispensador.



Nota:

- No utilice agentes abrasivos o cáusticos para limpiar las piezas de plástico.
- Limpie el dispensador de detergente cada 3 meses para asegurarse de que el aparato funcione con normalidad.

Limpieza del filtro de la bomba de desagüe



¡Advertencia!

- Asegúrese de que la lavadora ha terminado el ciclo de lavado y está vacía. Apáguela y desenchúfela antes de limpiar el filtro de la bomba de desagüe.
- Tenga cuidado con el agua caliente. Espere a que el agua se enfríe. ¡Riesgo de quemaduras!
- Limpie el filtro periódicamente cada 3 meses para asegurarse de que el aparato funcione con normalidad.

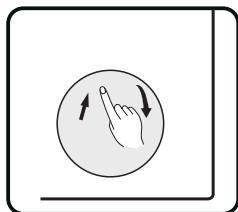

①



②

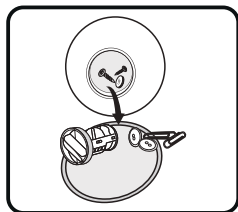

③

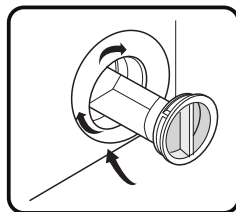

④

1. Abra la tapa inferior.
2. Abra el filtro girándolo en el sentido contrario a las agujas del reloj.
3. Elimine cualquier materia extraña.
4. Cierre la tapa inferior.





¡Precaución!

- Cuando el aparato esté en funcionamiento, y dependiendo del programa seleccionado, puede haber agua caliente en la bomba. Nunca retire la tapa de la bomba durante un ciclo de lavado, espere siempre a que el aparato haya terminado el ciclo y esté vacío. Cuando vuelva a colocar la tapa, asegúrese de que la vuelve a apretar firmemente.

Solución de problemas

Siempre que haya un problema con el aparato, compruebe si puede solucionarlo usted mismo siguiendo las siguientes tablas.

Descripción	Posible causa	Solución
El aparato no se inicia	<ul style="list-style-type: none"> • La puerta no está bien cerrada. • La ropa está atascada. 	<ul style="list-style-type: none"> • Cierre la puerta correctamente y reinicie. • Revise la ropa.
No se puede abrir la puerta	<ul style="list-style-type: none"> • La protección de seguridad está activada. 	<ul style="list-style-type: none"> • Desconecte la alimentación y reinicie.
Fugas de agua	<ul style="list-style-type: none"> • Las conexiones no están lo suficientemente apretadas. 	<ul style="list-style-type: none"> • Revise y deje bien sujeta la manguera de entrada de agua. • Revise y limpie la manguera de salida.
Residuos de detergente en el dosificador de detergente	<ul style="list-style-type: none"> • El detergente está húmedo y/u obstruido. 	<ul style="list-style-type: none"> • Limpie y seque el dispensador de detergente.
El indicador o la pantalla no funcionan	<ul style="list-style-type: none"> • La placa de circuito impreso o el cableado tienen problemas de conexión. 	<ul style="list-style-type: none"> • Apague el aparato y compruebe si el enchufe está conectado correctamente.
Ruido anormal	<ul style="list-style-type: none"> • Los pernos de fijación siguen en su posición. • El suelo no es firme o no está nivelado. 	<ul style="list-style-type: none"> • Compruebe si se han retirado los pernos de fijación. • Asegúrese de que el aparato esté instalado sobre un suelo firme y nivelado.

Descripción	Posible causa	Solución
Códigos de error		
 	Pausa/inicio Sin centrifugado Aclarado extra	Prelavado
Apagado Apagado Flash Apagado Apagado	<ul style="list-style-type: none"> La puerta no está bien cerrada. 	<ul style="list-style-type: none"> Reinicie después de cerrar la puerta. Compruebe si hay ropa atascada.
Apagado Apagado Apagado Flash Apagado Apagado	<ul style="list-style-type: none"> Problema de inyección de agua durante el lavado. 	<ul style="list-style-type: none"> Compruebe si la presión del agua es demasiado baja. Enderece la manguera de agua. Compruebe si el filtro de la válvula de entrada está obstruido.
Apagado Apagado Flash Flash Apagado Apagado	<ul style="list-style-type: none"> El desagüe del agua tarda demasiado tiempo. 	<ul style="list-style-type: none"> Revise el tubo de desagüe por si estuviera obstruido.
Apagado Apagado Apagado Apagado Flash Apagado	<ul style="list-style-type: none"> Desbordamiento del agua. 	<ul style="list-style-type: none"> Reinicie la lavadora.
	<ul style="list-style-type: none"> Otros 	<ul style="list-style-type: none"> Inténtelo de nuevo primero, llame al teléfono de asistencia si persisten los problemas.

Transporte

PASOS IMPORTANTES AL MOVER EL APARATO

- Desenchufe el aparato y cierre el grifo de entrada de agua.
- Compruebe si la puerta y el dispensador de detergente están cerrados correctamente.
- Retire la manguera de entrada de agua y la manguera de salida de las instalaciones domésticas.
- Desagüe completamente el agua del aparato (consulte el apartado «Limpieza del filtro de la bomba de desagüe»)
- Importante: Vuelva a instalar los 4 pernos de transporte en la parte trasera del aparato.
- Este aparato es pesado. Transpórtelo con cuidado. Nunca sostenga ninguna parte sobresaliente de la lavadora cuando la levante. La puerta de la lavadora no se puede utilizar como asa.

Ficha del producto

Nombre del proveedor o marca comercial^{(a),(c)}:

Dirección del proveedor^{(a),(c)}:

Identificador del modelo ^{(a),:} WF 510 D W566C

Parámetros generales del producto:

Parámetro	Valor		Parámetro	Valor	
Capacidad nominal ^(b) (kg)	5,0		Dimensiones en cm ^{(a),(c)}	Altura	85
				Anchura	60
				Profundidad	40
Índice de eficiencia energética (EEL _w) ^(b)	79,9		Clase de eficiencia energética ^(b)	D ^(d)	
Índice de eficiencia de lavado ^(b)	1,031		Eficacia del aclarado (g/kg) ^(b)	5,0	
Consumo de energía en kWh por ciclo, basado en el programa eco 40-60. El consumo de energía real dependerá de cómo se utilice el aparato.	0,602		Consumo de agua en litros por ciclo, basado en el programa eco 40-60. El consumo de agua real dependerá de cómo se utilice el aparato y de la dureza del agua.	41	
Temperatura máxima en el interior del textil tratado ^(b) (°C)	Capacidad nominal	37	Contenido ponderado de humedad restante ^(b) (%)	71,9	
	Media carga	31			
	Cuarto de carga	28			
Velocidad de centrifugado ^(b) (rpm)	Capacidad nominal	1 000	Clase de eficiencia de secado por centrifugado ^(b)	D ^(d)	
	Media carga	1 000			
	Cuarto de carga	1 000			

Ficha del producto

Duración del programa ^(b) (h:min)	Capacidad nominal	3:08	Tipo	independiente
	Media carga	2:30		
	Cuarto de carga	2:30		
Emisiones de ruido acústico aéreo en la fase de centrifugado ^(b) (dB(A) re 1 pW)	79	Clase de emisión de ruido acústico aéreo(fase de centrifugado)	C ^(d)	
Modo desactivado (W) (si procede)	0,50	Modo de espera (W) (si procede)	1,00	
Retardo en el inicio (W) (si procede)	4,00	Modo de espera en red (W) (si procede)	N/A	

Duración mínima de la garantía ofrecida por el proveedor^{(a),(c)}:

Este producto ha sido diseñado para liberar iones de plata durante el ciclo de lavado

NO

Más información:

Enlace web al sitio web del proveedor, donde se encuentra la información del apartado 9 del anexo II del Reglamento de la Comisión (UE) 2019/2023⁽¹⁾:

^(a) este punto no se considerará relevante a efectos del artículo 2, apartado 6, del Reglamento (UE) 2017/1369,

^(b) para el programa eco 40-60.

^(c) las modificaciones de estos puntos no se considerarán relevantes a efectos del artículo 4, apartado 4, del Reglamento (UE) 2017/1369.

^(d) si la base de datos de productos genera automáticamente el contenido definitivo de esta celda, el proveedor no introducirá estos datos.







WARRANTY CONDITIONS

EN

This product is guaranteed against faults caused by defects in manufacturing or the materials used for a period of two years, starting from the date of purchase.* This warranty does not cover defects or damage caused by failure to install the device correctly, incorrect use of the product, or excessive wear and tear.

*proof of purchase required.

CONDITION DE GARANTIE

FR

Ce produit est garanti pour une période de 2 ans à partir de la date d'achat*, contre toute défaillance résultant d'un vice de fabrication ou de matériau. Cette garantie ne couvre pas les vices ou les dommages résultant d'une mauvaise installation, d'une utilisation incorrecte ou de l'usure anormale du produit.

*sur présentation du ticket de caisse.

GARANTIEVOORWAARDEN

NL

Dit product wordt gegarandeerd voor een periode van 2 jaar vanaf de aankoopdatum*, voor elke storing die het gevolg is van een fabricagefout of het materiaal. Gebreken of schade door slechte installatie, onjuist gebruik of abnormale slijtage van het product worden niet gedekt door deze garantie.

*op vertoon van kassabon.

CONDICIONES DE GARANTÍA

ES

El certificado de garantía de este producto tiene una duración de 2 años a partir de la fecha de compra* que se limita a los defectos de fabricación y averías del material. Se excluyen de la garantía deficiencias o daños originados por una mala instalación, errores en la manipulación o por un uso inadecuado.

*previa presentación del comprobante de compra.

ELECTRO DEPOT

1 route de Vendeville

59155 FACHES-THUMESNIL - FRANCE

